

The Nansemond Ghost Fleet



Nansemond River

Archaeological Investigations of a Vessel Abandonment Area in Suffolk, Virginia

ARCHAEOLOGICAL REPORT No. 24, DEPARTMENT OF HISTORIC RESOURCES
& Longwood Institute of Archaeology

© 2020 Virginia Department of Historic Resources

This report is the result of an archaeological investigation funded by a Threatened Sites grant. Since 1985, the Department of Historic Resources has administered a program for threatened archaeological sites in Virginia. Sites considered for funding must be at least of statewide significance and under threat of destruction, sites such as the "Nansemond Ghost Fleet."

Eligible threatened sites also are ones for which no other source of funding is available for their rescue. Anyone may bring these sites to DHR's attention.

DHR evaluates potential sites in collaboration with a Threatened Sites Committee composed of members of the archaeological community. Funds are committed for assessment, excavation, laboratory processing and analysis, and reporting.

Volunteers and the public are involved at every possible opportunity.

For copies of reports from these projects, visit the DHR website (www.dhr.virginia.gov) and go to the DHR Archaeological Report Series. A list of other titles in the series is provided on the last page of this report.

For more information about the Threatened Sites Program, please visit our website or contact Elizabeth Moore, State Archaeologist.

Virginia Department of Historic Resources
2801 Kensington Avenue
Richmond, VA 23221
(804) 482-6446

The Nansemond Ghost Fleet

Archaeological Investigations of a Vessel Abandonment Area in Suffolk, Virginia

Prepared for the Department of Historic Resources by

P. Brendan Burke

Brian D. Bates

Robin Ramey

Longwood Institute of Archaeology

Longwood University

201 High Street

Farmville, Virginia 23909

With Contributions by

Austin Burkhard

Nicholas Budsberg

Chuck Meide

Abstract:

The Nansemond Ghost Fleet, 44SK0631, is a cluster of maritime resources contained within the Nansemond River and its banks near downtown Suffolk, Virginia. The site contains historic watercraft of various natures, foreshore components from industrial enterprises along the river, and a sheet midden of historic artifacts pertaining to the inhabitation and industrial background of Suffolk, and historic Nansemond County. In 2019 DHR awarded a Threatened Sites Grant to the Longwood University Institute for Archaeology to undertake an archaeological reconnaissance of the Nansemond River to locate the extent of the resource group and document those findings. The Lighthouse Archaeological Maritime Program (LAMP) and the Archeological Society of Virginia – Maritime Heritage Chapter (MHC) joined Longwood University to provide archival and field assistance. An initial field period occurred during early October of 2019 and a second phase of laser scanning and 3D imaging took place during February of 2020. Project findings indicate that this site contains elements of transportation and technological innovation connected to the modern industrial development of Suffolk, specifically the fishing and lumbering industries. Vessel types encountered included small craft such as a planked double-ended craft, a likely crab scrape, a log-bottomed vessel, at least one bug-eye, a possible buyboat, a scow schooner, barges, a small powered pleasure craft, and a number of unidentified watercraft. This assemblage is unique for the diversity of watercraft types and levels of preservation.

CONTENTS

Introduction	12
Acknowledgments	13
Research Design	14
Documentary Research	14
Fieldwork	14
Recording Methods	14
3D Photogrammetric Modelling	16
Traditional Documentation	17
Historic Context: Geography and Culture	18
Geographic Setting	18
Maritime History of the Nansemond River and Suffolk, Virginia	19
The Oyster Industry in Suffolk	21
W. N. McAnge — Suffolk Oyster Magnate	22
Survey Results	27
Feature 1: Pilings	27
Feature 2: Unidentified Vessel Remains	27
Feature 3: Barge	30
Feature 4: Double Ended Skiff	30
Feature 5: Funkhouser Fleet	30
Feature 6: Creek Pilings	41
Feature 7: Logboat Hull	42
Feature 8: Wooden Vessel	43
Feature 9: Wooden Vessel	43
Feature 10: Wooden Vessel	44
Feature 11: Bugeye (Hobbs Wreck)	45
Feature 12: McAnge Oyster House Wharf	55
Feature 13: Wooden Power Boat	56
Feature 14: Cribbing	57
Feature 15: North Bank Pilings	59
Digital Recordation of Site 44SK0631	60
Post-Field Data Processing and Project Deliverables	60
Summary and Recommendations	62
Works Cited	63
Appendix 1. Feature 11, The Hobbs Wreck, 3-D Model Imagery	65
Appendix 2. Laser Imagery Gathered From The Funkhouser Fleet and Hobbs Wreck	69
Appendix 3. Selected Side Imaging Sonar Views	74

Appendix 4: Acoustic Contacts Report	78
Appendix 5: Field Drawings and Selected Notes	114
Appendix 6: Mid-Atlantic Logboat Registry: Notes from Riddick's Folly Museum, Log Boat, Feature 7	117

LIST OF FIGURES

Figure 1. <i>Overview of project location.</i>	15
Figure 2. <i>Survey area for the Nansemond Ghost Fleet Project.</i>	15
Figure 3. <i>Dr. John Broadwater, Virginia State Underwater Archaeologist, assists with field recordation of the Hobbs Wreck.</i>	16
Figure 4. <i>The R/V Nansemond rigged for side-imaging sonar.</i>	17
Figure 5. <i>The recording team documented vessel offsets during the October field expedition.</i>	18
Figure 6. <i>Inset of the John Smith map of 1612, showing the Nansemond River.</i>	19
Figure 7. <i>Inset of 1863 map of Suffolk showing the Nansemond River.</i>	21
Figure 8. <i>William Norman McAnge, as sketched in the Atlanta Constitution, September 7, 1890.</i>	22
Figure 9. <i>Detail from an advertisement for McAnge’s oyster house showing the post-1889 expansion to include a larger canning room.</i>	23
Figure 10. <i>An 1898 Sanborn Fire Insurance Map depicting McAnge’s oyster house, wharf, canning plant, and limekiln.</i>	23
Figure 12. <i>Oyster leases owned by W. N. McAnge Oyster Company.</i>	24
Figure 11. <i>Detail from a 1907 “Bird’s eye view of Suffolk, Virginia” showing commerce on and around the Nansemond River.</i>	24
Figure 13. <i>This image, published in Edward Pollock’s 1886 Sketch Book of Suffolk, depicts the oyster house and fleet operated by William Norman McAnge and a diverse array of vessels on the river.</i>	25
Figure 14. <i>Advertisement from the North Carolina Christian Advocate, March 14, 1912 for McAnge’s Agricultural Lime, produced as a byproduct of the oyster business.</i>	26
Figure 15. <i>Advertisement for the McAnge Oyster Company published in Edward Pollock’s Sketch Book of Suffolk in 1886.</i>	26
Figure 16. <i>Features identified within 44SK0631.</i>	27
Figure 17. <i>Feature 1 as it appears in 2014 Google Earth aerial imagery.</i>	28
Figure 18. <i>Inset of the 1920 Sanborn Fire Insurance map showing a frame platform extending into the river.</i>	28
Figure 19. <i>Feature 2 vessel remains.</i>	29
Figure 20. <i>Oyster houses operated by W. N. McAnge and Peter Smith shown on the 1920 Sanborn Fire Insurance map.</i>	29

Figure 21. Feature 3, remains of a small wood barge.	30
Figure 22. Feature 4, a double-ended skiff seen in the foreground.	31
Figure 23. In this 1941 photo by M. V. Brewington a double-ended skiff is shown out of the water.	31
Figure 24. Feature 5, the "Funkhouser Fleet" as viewed by side-imaging sonar.	32
Figure 25. Feature 5, the "Funkhouser Fleet."	32
Figure 26. The bow of Vessel 1 of Feature 5, the Funkhouser Fleet.	33
Figure 27. Laser point cloud data of Vessel 1 and 2 showing the keelson, framing, and cant frames.	34
Figure 28. Vessel 2 of Feature 5, the Funkhouser Fleet.	34
Figure 29. Vessel 2 of Feature 5, the Funkhouser Fleet, seen in laser point cloud. Note the difference in profile from Vessel 1.	35
Figure 30. Vessel 3 of Feature 5, the Funkhouser Fleet.	35
Figure 31. Vessel 4 of Feature 5, the Funkhouser Fleet.	36
Figure 32. The skipjack E. C. Collier on the marine ways in 1988.	37
Figure 33. (Pages 38-39). Lines of the Caleb Jones, a traditional skipjack.	37
Figure 34. Vessel 5 of Feature 5, the Funkhouser Fleet.	37
Figure 35. Vessel 6 of Feature 5, the Funkhouser Fleet.	40
Figure 36. Vessel 6 of Feature 5, the Funkhouser Fleet. Side imaging data gathered on October 12, 2019, during a period of unusual high water, first identified this vessel. Range lines on the image are in feet.	41
Figure 37. Three-cylinder engine on Vessel 6 of Feature 5. Note the flywheel, facing forward on the vessel.	41
Figure 38. Feature 7, the keel log of a log-bottomed boat found near the Nansemond River.	42
Figure 39. The bow section of a vessel is seen here with five strakes emerging from the mud (center and right-hand) with a keelson (left-hand) seen sticking out of the mud with a copper-allow through-bolt present.	43

Figure 40. Feature 9, an unidentified flat-bottomed skiff.	44
Figure 41. Crabbing skiff documented by M. V. Brewington in 1937.	44
Figure 42. Inset of photo taken by M. V. Brewington of a crabbing skiff interior during a 1937 survey of Chesapeake Bay craft. Note the cross-planked interior, similar to planking recorded in Feature 10.	45
Figure 43. Feature 10, a wooden crabbing skiff hull. Note the scarf joint in the keelson.	45
Figure 44. Field drawing and table of offsets from Feature 10.	46
Figure 45. Feature 11, the Hobbs Wreck. Timber plan recorded during October 2019 field expedition.	48
Figure 46. Inset of photograph taken by George Barrie in 1904 showing a square-rigged bugeye.	50
Figure 47. The Hobbs Wreck, Feature 11, shown in orthoimagery. The bow is oriented to the right in this photo and north is to the left. Note the mainmast step, located ahead of the aftermost extent of the centerboard trunk. This feature indicates a schooner, or square-rigged, bugeye.	50
Figure 48. Feature 11, the Hobbs Wreck, looking from stern to bow. Note deadwood facing the camera, the sternpost fell away from the wreck sometime between February 13, 2020 and March 10, 2020.	51
Figure 49. Plan drawing of Feature 11, the Hobbs Wreck.	52
Figure 50. Feature 11 cross section view at centerboard trunk.	53
Figure 51. Hobbs Site in longitudinal section. The top image colors each timber independently.	54
Figure 52. Feature 41, pilings associated with the McAnge Oyster Company wharf and processing facility. Note Feature 10, the Hobbs Site, in the left-hand background.	55
Figure 53. Sanborn Fire Insurance Map of 1898 showing the McAnge Oyster Company wharf and processing facility. (Courtesy, Suffolk Nansemond Historical Society)	55
Figure 55. Detail of the Feature 13 boat. Note two layers of diagonally-laid planks and copper-alloy screws at frame stations. A frame is seen in the middle left-hand side of the picture and the engine is in the background.	56
Figure 56. Cribbing west of the Main Street Bridge exposed during an unusually low tide in March 2020.	57
Figure 56a. Feature 14 is located approximately where the picket fence and small buildings to the right are drawn on this Harper's Weekly depiction of downtown Suffolk in March of 1863.	58

Figure 57.
1888 Sanborn Fire Insurance Map showing the area of Feature 14. [58](#)

Figure 58.
Area of Feature 14, depicted on a 1921 Sanborn Fire Insurance Company Map. Cribbing and pilings associated with Feature 14 possibly relate to the construction of this building and wharf. [58](#)

Figure 59.
Feature 15 is seen in the right-hand portion of this aerial photo taken on October 14, 2019. [59](#)

LIST OF TABLES

Table 1. Listing of known vessels owned by W. N. McAnge Oyster Co. *U.S. Customs House tonnage calculations allowed 20 bushels of oysters to 1 net ton (Brewington 1963:115). [25](#)

Table 2.
Vessel 1 scantlings. [34](#)

Table 3.
Vessel 2 Scantlings. [35](#)

INTRODUCTION

In early 2017, during an exceptionally low tide on the Nansemond River, Kermit Hobbs (Historian, Suffolk-Nansemond Historical Society) and John Cross discovered a cluster of wooden vessels that appeared to form an abandoned vessel graveyard in the vicinity of the Main Street Bridge near downtown Suffolk, Virginia. Mr. Hobbs captured drone video of the vessels and named the area the "Nansemond River Ghost Fleet." In 2018 Kermit Hobbs and Lee King of Riddick's Folly House Museum shared the video with Robert and Mary Hayes, members of the Archeological Society of Virginia – Maritime Heritage Chapter (MHC). Mr. and Mrs. Hayes subsequently shared the video with MHC members, including archaeologists from the St. Augustine Lighthouse Archaeological Maritime Program (LAMP). Interest in the Nansemond Ghost Fleet grew, and the MHC decided to further investigate the site.

A site visit on June 14, 2019 by MHC members and a representative from LAMP yielded additional evidence of an abandoned maritime complex including rows of pilings and more vessel remains. Field discoveries made during that visit indicated a need for in-depth exploration of the locale to document the full extent of maritime archaeological elements within, and beside the Nansemond River. The Longwood Institute of Archaeology (IoA), joined by the LAMP and the MHC filed a Threatened Sites Grant Application with the Virginia Department of Historic Resources (DHR) in May of 2019.

From September 30 to October 15, 2019, a team of archaeologists from LAMP investigated the Nansemond Ghost Fleet. During this field phase, the team identified thirteen vessels along the Nansemond River foreshore and submerged within the river. The team survey 60.5 acres for cultural materials, and used side-imaging sonar to interrogate inundated areas. Archival research was carried out during periods of inclement weather and when site access was limited by high tides. A second field phase was conducted from February 11-13, 2020. Independent researcher Brendan Burke joined archaeologists from Longwood University, led by Dr. Brian Bates, to deploy 3D scanning and full-field photographic equipment to record historic vessels within the area. All field activities were conducted under Virginia Marine Resour-

ces Commission Permit #2018-05-07. Resources included in the Nansemond Ghost Fleet area reside on private and public lands. Where privately owned, permission was requested of landowners, or their agent, for access to document archaeological materials.

Field investigations during the October phase were conducted by Brendan Burke, M.A., Associate Director for Archaeological Research (LAMP) and included Chuck Meide, M.A., Director of Archaeological Research (LAMP), Nicholas Budsberg, M.A., Archaeologist (LAMP), Austin Burkhard, M.A., Archaeologist and Dive Safety Officer (LAMP), Bill Utley (MHC), and Levi Holton (MHC). Ashley Bassetti-McCuistion, M.A., of Fairfield Foundation, conducted drone survey of the site during the October phase and Brandon Andrews donated drone reconnaissance to the project.

All aspects of this investigation conformed to guidelines established in Section 106 of the National Historic Preservation Act of 1966, as amended (Advisory Council on Historic Preservation 2014), the *Secretary of the Interior's Standards and Guidelines for Archeology and Historic Preservation* (National Park Service 1983) and the requirements outlined by the Virginia Department of Historic Resources (DHR) in *Guidelines for Conducting Historic Resources Survey in Virginia* (Department of Historic Resources 2011). Copies of all field notes, maps, correspondence, and historical research materials are on file at the Institute of Archaeology's office at Longwood University in Farmville, Virginia or with the Lighthouse Archaeological Maritime Program at the St. Augustine Lighthouse & Maritime Museum in St. Augustine, Florida. No artifacts or samples were collected during this project.

ACKNOWLEDGMENTS

A community of effort went into making this project a success. First, Mr. Kermit Hobbs brought the Nansemond Ghost Fleet to the public through his drone documentation. He persisted to ensure the resource received attention and due scholarship. During the October field expedition, he was a constant supporter, including the loan of his small but capable research vessel, the R/V *Nansemond*. Lee King, Chief Curator at Riddick's Folly Museum, has remained gracious and ever-supporting during the entire project. He generously offered his office as a meeting space and provided tours of the museum to all project volunteers and staff. Additionally, his assistance with historical documentation was most helpful.

Mr. Robert Funkhouser and family kindly allowed access to the Feature 5 vessels, which became known as the Funkhouser Fleet. Walgreens of Suffolk also allowed access to the foreshore to record features along the intertidal zone. Thank you.

Dr. John Broadwater has been a tireless advocate for maritime studies and archaeology in Virginia. Whether working on the Yorktown wrecks or the most mundane vernacular craft, his enthusiasm and professional dedication remains the same. John was an early proponent of this project and stayed with it through the completion of this phase.

Levi Holton, MHC volunteer, lent his time to assist the field crew in recording the Hobbs Site. Bob and Mary Hayes gave their time and skill to the project; their friendship and dedication to the field is irreplaceable. Kimberly Blair Greene, Executive Director of the Suffolk Nansemond Historical Society, assisted in every way possible. She arranged the loan of kayaks and volunteer assistance with the society's research library, two invaluable parts of the October field expedition. Kevin Whitehurst of the City of Suffolk Parks and Recreation Division generously offered mooring space in the city marina.

Humminbird, manufacturer of side-imaging sonar, generously donated a Helix 12 to the LAMP program in 2019. The portable device enabled the field crew to continue working when the tides prevented wreck documen-

tation. Mr. Devin Patel, owner of the Suffolk Super 8 motel, patiently allowed our field crew and site visitors access to the foreshore. Fairfield Foundation generously supported the project via the deployment of strategic assets Ashley McCuiston and the drone *Major Tom*. Brandon Upright also lent time on his drones to monitor the site.

Finally, a debt of gratitude is owed to the Virginia Department of Historic Resources and the volunteer members of the Threatened Sites Committee for selecting this project for funding. Thank you.

RESEARCH DESIGN

The objective of this investigation was to identify archaeological materials and features within a selected area of the Nansemond River and to provide a preliminary assessment of their research potential through documentation and analysis. Research methods included archival research, historic map projection, systematic side-imaging sonar survey, 3D laser scanning, traditional mapping/drawing, and pedestrian survey of intertidal foreshore.

Documentary Research

During the initial stage of this investigation, the Virginia Department of Historic Resources' (DHR) Virginia Cultural Resource Information System (V-CRIS) was queried to identify the types of archaeological and architectural resources previously recorded in the project vicinity. Additionally, repositories of historic documents pertaining to the maritime history of the Chesapeake Bay, Nansemond River, Suffolk, and Nansemond County were investigated for primary and secondary source documents related to the Nansemond Ghost Fleet. Archives and libraries tapped in this research include the Suffolk Nansemond Historical Society, the Library of Virginia, the Library of Congress, the Mariners' Museum, and numerous online repositories.

Fieldwork

The project area (Figure 1) was initially outlined as the immediate vicinity of the tidally-exposed vessel remains identified in the Hobbs drone footage from 2017. During the October field phase, a canoe survey of adjacent shoreline indicated a larger area of historic materials. Accordingly, the survey area expanded to include waters and shorelines lying between the Lake Meade dam on the upriver side and the Main Street Bridge on the downriver side (Figure 2).

Between October 8 and October 12, the Nansemond River was unusually high due to a low-pressure system off the Mid-Atlantic coast. Strong northeast winds prevented tidal waters from receding and the project area was flooded. During this period, archival work was con-

ducted, field drawings created from data, and side imaging survey areas were expanded to include the Nansemond River from the Main Street Bridge to a point 0.17 miles below the mouth of Shingle Creek, and including Shingle Creek as far upstream as the Oak Island Road bridge.

Primary mapping of features was completed with a Trimble Geo7x at sub-decimeter accuracy. Side imaging data was gathered with a Humminbird Helix 12 and postprocessed in Hypack and SonarWiz for bottom tracking, targeting, and mosaicking (Figure 4). All new resources were entered into VCRIS.

RECORDING METHODS

Feature 11, the Hobbs Wreck, was selected for detailed recording during the 2019 field season. Investigators chose the site because low tide exposes it, substantial hull remains are intact and articulated, and the feature is the most easily accessed of any at the site. For these same reasons, the Hobbs Site is also the most threatened vessel in the fleet.

A multivariate approach was utilized to best document the site over a 16-day period. Five different methodological techniques formed the backbone of the recordation methodology including traditional ink-on-paper methods as well as newer ones aided by recent advances in technology. First, visual assessments were conducted and qualitative information was recorded into field notebooks. Second, pre-disturbance photographs were taken for two distinct purposes: general documentation of the site and its key features as well as a series of overlapping photographs taken to construct a scaled, three-dimensional photogrammetric model. The photographs were taken while the site was most exposed during the lowest predicted tide available during the field season.

Third, quantitative measurements were taken directly from the articulated timbers and specific construction features were also drawn and measured (Figure 3). Fourth, aerial imagery and video were captured using an unmanned aerial vehicle (UAV) to assist with spatially understanding the site within the greater environ-

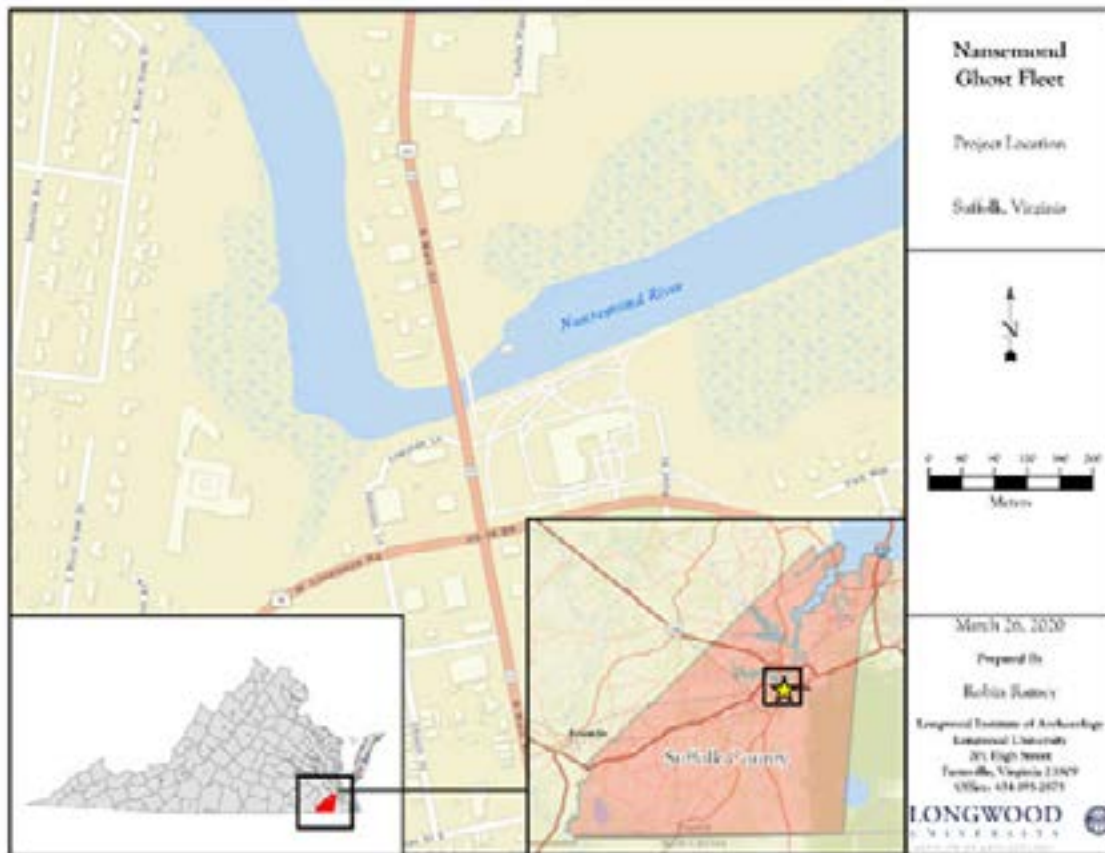

Figure 1. Overview of project location.

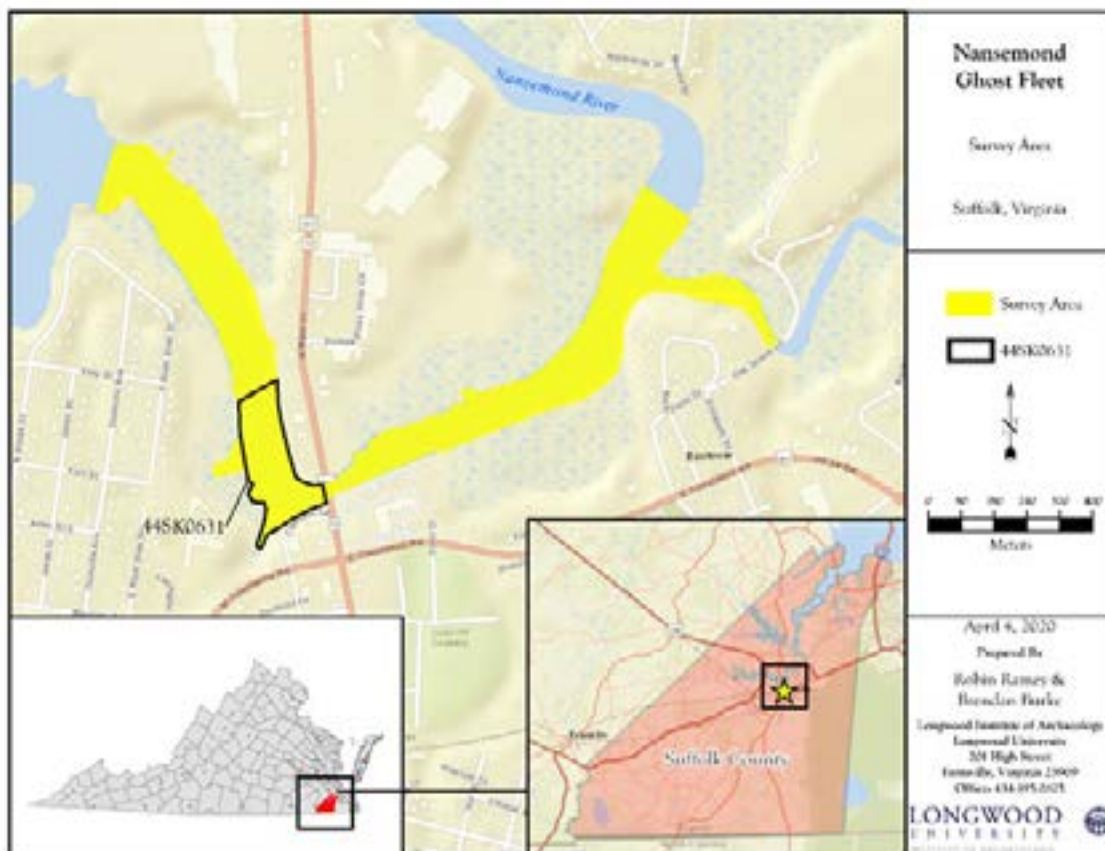

Figure 2. Survey area for the Nansmond Ghost Fleet Project.

ment. Fifth, a laser scanning system recorded the specific geometry of the structure and its position relative to the other historical features. Used in tandem with one another, these many technologies result in a very robust, overlapping dataset, captured in a relatively short amount of time, and requiring little intensive activity.

3D Photogrammetric Modelling

Photographs for the 3D photogrammetric model were taken and a low-resolution model was constructed onsite using Agisoft Metashape software. Building a photo-model before intensive activities is an excellent way to capture much of the physical and visual data present at the site before changes occur due to field-work activities. Future photo-models can be built as work progresses and the initial model can be used to qualitatively and quantitatively compare the changes over time using different software programs. Photogrammetry provides other benefits as well, such as the ability to print the site with a 3D printer at any scale, making it an important tool for the modern archaeologist's toolkit. A more detailed and accurate photo-model was built in the months following the field season once additional computing power could be accessed in the lab.

To control the modelling process, folding rulers were used as scale bars and placed around the site while measurements from the hull were used to check the accuracy of the final model. Because the site was partially submerged in water, it was difficult for the photo-modelling software to reconstruct the aft portion of the site with high accuracy. While photo-models are effective for sites both above and below water, partially submerged sites are more challenging. For shoreline sites in the tidal zone that are along a low-grade slope, such as with the Hobbs Site, the portions under water are not deep enough to submerge the camera and capture appropriate photographic data. As a result, light is distorted as it passes from the surface to the site features below and the computer programs are not able to accurately process the refraction. Reflective surfaces of all types, including the glare from the surface of the water, are also not easily modelled.

When compared to linear measures of timbers



Figure 3. Dr. John Broadwater, Virginia State Underwater Archaeologist, assists with field recordation of the Hobbs Wreck.

taken by hand they were accurate between 0 and 2 cm. The model's recorded scale bar accuracy is 0.5 cm. However, for measurements of submerged timbers their accuracy was between 2 and 5 cm. For technical reference, the best statistic for measuring the overall accuracy of a 3D photogrammetric model is the root mean square (RMS) value calculated by the program. For the Hobbs Wreck model, the lowest RMS value obtainable was 1.7. Highly accurate models tend to fall between values of 0.5 and 1.0. Traditional error reduction methods (such as deleting pixels via the Gradual Selection menu) were also noticed to be less effective because of the submerged features. New error reduction and post-processing techniques are being tested to improve the overall RMS for photogrammetric data sets of sites such as this. A 3D model of the site may be viewed at <https://sketchfab.com/3d-models/hobbs-shipwreck-909c6e6ef0734de-39441583c004a9315>



*Figure 4.
The R/V Nansemond
rigged for side-
imaging sonar. It
used a 30-lb thrust
trolling motor for
propulsion and a
secondary 12VDC
battery to power
the sonar unit.
Positioning was
acquired using a
built-in GPS antenna
and only collected
with an HDOP of
<1.1.*

Traditional Documentation

Hand measurement using folding rulers and measuring tapes followed the pre-disturbance photogrammetry (Figure 5). Documenting accurate measurements of the site required moving mud and glass shards aside. The artifacts moved to record consisted of a surface scatter of historic glass and modern trash. This lens appears to be generally disturbed but was only moved a few feet via hose washing. The October 2019 recording phase targeted only notable construction areas.

To record the curves, multiple methods were discussed, although the final choice was to use offset measures from an installed baseline. A taught line and line level were stretched across two fiberglass rods that were inserted into the river bottom on either end of the frame being measured. A measuring tape also was stretched between the two rods and the forward most frame of each pair was used for consistency. Persons stationed on either end of the line helped keep the line taught and level, and a third person used a folding ruler and plumb bob to gather the offset measure from the taught line to the interior face of the hull planking. The inner planking face represents the faired curvature of the hull of the vessel as shipwrights

intended when they first shaped the external frame face, to which the planking is fixed. For researchers seeking to reconstruct the original shape of the ship, these curves are critical.

Six frame curves were recorded along the starboard side (Figure 45). Curves of the port side were tested; however, these frames were noticeably distorted and only measures of the starboard side were taken for each set. The offset measure was taken at periodic intervals along the frame. Spacing between offset measures ranged between 30cm and 5cm depending on the obstacles encountered and the steepness of the curve being recorded. These measurements were recorded and the curves later sketched to assess their accuracy. Frames were labeled 1 through 28 from bow to stern and curvatures were recorded for frames 1, 6, 13, 18, 23 and 28. Note that after the frames were numbered and recorded, the bow section was further exposed for recordation and another pair of frames was identified forward of Frame 1. This frame was labeled Frame 0 to keep the numbering system intact, resulting in a total of 29 surviving frames at the Hobbs Site numbered 0-28.



Figure 5.
The recording
team documented
vessel offsets during
the October field
expedition. (Courtesy
of the *Virginian Pilot*)

Frames 1 and 28 were the fore and aft-most frames identified at the time; frame 18 is the master frame; frame 13 is the longest frame length surviving and near the centerline of the hull; frames 6 and 23 filled the gap between the fore and aft-most frames and the next measured pairs. In the future, these frame curves combined with the other hand measures, the photogrammetric data, the highly accurate geometric data from the laser scanner, and construction data from similar ship types will allow a set of ship's lines to be reverse engineered for the vessel. This enables archaeologists to reconstruct the original curvature of the vessel and better understand the ship's sailing characteristics and hull design as engineered by the shipwrights a century ago.

A table of scantlings was created, and sketches of key features were made including of the mast steps, bow construction, curvature of select frames, and the centerboard trunk. These were used to create a hand-drawn site plan of articulated timbers; a necessary figure for recording and sharing the full surviving structure of the vessel, especially the curvature of the frames.

HISTORIC CONTEXT: GEOGRAPHY AND CULTURE

Geographic Setting

The Nansemond River is a principle tributary of the lower James River located within the City of Suffolk, formerly Nansemond County. Modern navigable waters extend from the confluence with the James River approximately eighteen miles upstream to the Main Street Bridge (Bus 460); the river is dammed 0.63 miles above the Main Street Bridge to form Lake Meade, the first of two freshwater impoundments serving the region's drinking water needs. Located within the Coastal Plain of Virginia, the topography is flat to gently rolling and forms a low-lying alluvial plain between the Atlantic Ocean and the Piedmont, a boundary defined by the fall line on Virginia's major eastern rivers. The Coastal Plain includes scarps that gradually step upwards and westward toward the Piedmont, an older structure comprised of resistant igneous and metamorphic formations.

Project elevations ranged from seven- to fifteen-feet a.m.s.l and the project area is located on the U.S.G.S. 7.5 Minute Suffolk Quadrangle. Project drainage is diverse and includes all cardinal aspects. Bohicket silty

clay loam predominates foreshore areas and transitions to siliceous sands below the tidal boundary. Much of the intertidal foreshore is exposed mudbank at low tide and fringed with tidal marshes dominated by wild cane (*Arundo donax*) and smooth cordgrass (*Spartina alterniflora*).

MARITIME HISTORY OF THE NANSEMOND RIVER AND SUFFOLK, VIRGINIA

During the proto-contact period (1559–1607) indigenous people to the Nansemond River basin were likely aware of European incursions and attempts to colonize present-day coastal North Carolina and Virginia. The region, known as Tsenacommacah by its native inhabitants, was also undergoing historically unprecedented periods of drought and cold (Lutz et al 2015:24). Additionally, it is believed (Gallivan et al 2006; Rountree 1990) that Algonquian-speaking peoples in eastern Virginia were under assault from northern Iroquoians during the late 16th century. The contested nature of the landscape also appeared to be in political transition under the leadership of Powhatan, architect of an emerging polity in the Tidewater region. Inhabitants along the Nansemond River, and throughout its basin, occupied several hamlets documented by John Smith in his earliest exploration of the Chesapeake Bay (Figure 6).

In 1609, an English attempt to expand into the Nansemond River turned into a tragic bell-

wether for Anglo-Powhatan relations. James Martin, George Percy, and sixty men shifted from Jamestown to the Nansemond River in March of 1609 to establish a fortified outpost on an island in the river. Failed attempts at negotiations between English intruders and the Nansemonds culminated in a bloody conflict marked by tragic loss of life on both sides and the desecration of an indigenous tomb (Rountree 2005:138). This event is believed to have been a catalyst for the First Anglo-Powhatan War, which raged sporadically until 1614 (Egloff and Woodward 2006; Rountree 1990).

Throughout the middle 17th century, the Nansemond River basin continued as a contested space; the Nansemond River served as the principal viaduct in and out of the region to the north. To the south of the Nansemond River lies the Blackwater River and the Great Dismal Swamp, drainages that fed the Albemarle Sound. Indigenous political alliances of the Nansemonds during the 17th century were split between northern Powhatan-influences and those of coastal North Carolina (Rountree 2005:44-45). By the 1630s, land patents began snapping up territory for English speculators including Lord Matrevers, who attempted to rename the river after himself (Neal 1959:12). In 1637 Upper Norfolk County was formed and was renamed Nansemond County in 1646, a name that persisted until consolidation with the City of Suffolk in 1976.

Rountree (1990: 84) documents a process of fracturing within the Nansemond group that by



Figure 6. Inset of the John Smith map of 1612, showing the Nansemond River. The cruciform symbol depicts the uppermost reach of Smith's survey. North is to the right. (Library of Congress)

the 1660s had split it into two groups; those who remained along the river were pushed generally southeast towards the northern fringe of the Great Dismal Swamp. In 1653, Robert Brasseur (Brashears), a French Huguenot living in Calvert County, Maryland established a bead factory on the Nansemond River. It was operated by French artisans and located on a 1200-acre patent taken out by Brasseur in return for transporting 24 people to the colony (Neal 1959:18). It took until 1724 for the first permanent Anglo settlement to be constructed on the upper Nansemond in what is now downtown Suffolk. John Constant constructed a dwelling and wharf along the southern bank of the river, a place just east of Main Street and presently occupied by a large hotel complex.

Constant's Wharf, as a central place of trade for the upper Nansemond, was recognized by the House of Burgesses in 1748 as a suitable place to establish a town. Nansemond Town was established downstream in 1705, and so the establishment of Constant's Wharf effectively finished out the Nansemond River as an Anglo-controlled space (Neal 1959:19). The growth of English colonies depended on establishing additional ports to handle an expanding fur and tobacco market. The Nansemond River, given its proximity to the Great Dismal Swamp, also created an export market for naval stores, commodities of increasing value to England's rapidly expanding merchant and naval enterprises. During the first half of the 18th century, Constant's Wharf served as a port of delivery for the region, an important distinction wherein foreign goods could be legally landed, and export commodities could be taxed and shipped. In 1742, Constant's Warehouse had grown to a magnitude that once again drew the attention of the legislature, who set off fifty acres to establish the town of Suffolk. As Neal (1959:20) points out, Suffolk became the only early settlement on the Nansemond River to grow, prosper, and survive into the modern era.

Shipbuilding on the Nansemond during the historic period involved the building of small craft for local use as well as larger vessels for blue-water trade. By the mid-18th century, it appears that shipwrights set up along the banks of the river to take advantage of copious timber resources of the region and proximity to multitudes of planters who required a constant stream of merchant ships to convey tobacco

and other commodities back to England and the West Indies. During the American Revolution at least one privateer, the brig *Dolphin*, was built by the Cowper shipyard and went on to suffer an unknown fate but was perhaps burned by Benedict Arnold in the James River. About the same time, British attention turned to Suffolk and their forces burned the town and waterfront on May 13, 1779. Shipbuilding, as a rebel enterprise, ended. (Neal 1959:36).

The early Federal period saw Suffolk reemerge as a port town. By 1843 Suffolk boasted ten stores, a large hotel, a castor oil factory, a new courthouse, and a mansion known as Riddick's Folly (Hobbs and Paquette 2006:26). Twenty years later, *Harper's Weekly* reported that Suffolk "was a small, filthy town of great antiquity, small population, little trade, and a great deal of Virginia dirt and Virginia pride" (Hobbs and Paquette 2006:26). Whatever bias was present in the author, it was clear that the Civil War had extinguished any promise of industry in Suffolk and relegated it to a wartime victim. The city, like most in Virginia, received its fair share of attention from both armies. During 1862, Suffolk remained as one of the few places of importance in the Tidewater region still under Confederate control, and one with a strategic Confederate rail junction. Confederates, however, lost control of the city on April 30, 1863 when Confederate forces abandoned Suffolk to support the Army of Northern Virginia against Union General Hooker's Chancellorsville Campaign. The Nansemond River served as a natural viaduct for U.S. gunboats (Figure 7) to patrol and maintain control over the region. Suffolk meanwhile fell into near abandonment, perhaps giving rise to the disparaging remarks published in *Harpers*.

During the late 1860s and into the 1870s the South writhed with economic ruin and wrecked infrastructure. Suffolk was no different. One of the elevating forces on the city was the Old Dominion Steamship Company. Connecting Suffolk to Norfolk via a three-hour voyage, the line continued to New York (a 24-hour run) and points throughout the Chesapeake and coastal North Carolina. Undoubtedly, this connection to northern capital ameliorated economic depression and got Suffolk back on the road to recovery. By the late 1870s, the city emerged from its post-war slump with vigor. Then the terminus of six railroads, Suffolk became a



Figure 7.
Inset of 1863 map of Suffolk showing the Nansemond River. Note the "draw bridge" notation, now the location of the fixed Main Street, or "Kimberly" bridge. (Library of Congress)

major transportation center in the Mid-Atlantic region. Most of the railroads operating in the city owned wharves on the Nansemond to trans-ship goods. Among primary exports was lumber, shingles, and processed cotton goods (Pollock 1899:101). Architectural review of the National Register of Historic Places (NRHP) inventory form shows multitudes of significant houses and urban structures built during the 1880s and 1890s. A new city newspaper, the *Suffolk Herald*, began printing during this period and Edward Pollock published *Sketch Book of Suffolk* (1886), a categorical inventory and biography of the city's industrial might. It is no surprise that the book reads as many celebratory tomes readily embraced by chambers of commerce throughout the South to showcase renewal and attract outside investment.

The Oyster Industry in Suffolk

Prior to the Civil War, the Nansemond County oyster industry produced canned oysters for regional markets and fresh oysters for local markets. A notable chapter in the antebellum oyster business was a skirmish in the spasmodic Oyster Wars that consumed oystering's history throughout the Chesapeake. Oyster wars sporadically plagued the industry as it grew through the 19th and early 20th centuries (Wennersten 1981). In March of 1850 Lt. F. Riddick, commanding the Suffolk Artillery

Company, led an expedition down the river from Suffolk aboard the steamer *Sun*. Joining Lt. Riddick were a number of citizens under the command of Nansemond County Sheriff Hugh Kelly. The posse was 'armed to the teeth' and out to apprehend oyster pirates at the mouth of the Nansemond. Predations undoubtedly had gone on for some time and led the municipality to defend the public oyster grounds. Without firing a shot, the Riddick posse rounded up twelve offending vessels and brought them back to Suffolk along with 75 men. Captains of the boats were each fined \$33.50 (approximately \$1,110 in 2020) and the event was hailed as the "greatest Naval [sic] victory on record!" (Maxwell 1850:117).

The Civil War shut down Virginia's oyster industry. Union gunboats patrolled the Nansemond River to limit traffic, fearing Confederate reprisal or intelligence gathering while many of the white fishermen served in the armies. Emancipated African Americans likely operated fisheries but little data exists on what many people likely perceived as an unimportant backwater economy. Cities such as Norfolk and Hampton, held by the U.S. Army, had their appetites for fish and oysters likely slaked by an ersatz industry that took advantage of an upset *status quo*. However, Suffolk's fishing industry almost surely dried up with the town until the arrival of peace in 1865.

Pollock (1886:111) attributes the post-war resurgence of the Nansemond oyster industry to H. D. Cooper, an agent for the Seaboard & Roanoke Railroad. Cooper had access to distant markets via the railroad and sought to import Yankee currency to a struggling post-war Suffolk. Henry D. Cowper is the first Suffolk oysterman known to have shipped fresh oysters on ice but with limited success as he died in 1872 (Saunders and Watson 1998).

W. N. McAnge — Suffolk Oyster Magnate

The scion of a turpentine magnate in Horry County, South Carolina, William Norman McAnge (Figure 8) moved to Suffolk in 1880 at the age of 22 (Evans 1899:1011-1012). His first pursuit was the lumber industry, a burgeoning trade in the city. In 1880, McAnge established an oyster house on the south bank of the Nansemond River west of the Main Street Bridge. McAnge's involvement in the oyster industry was transformational for Suffolk's maritime commerce and developed oyster processing/sales into a modernized intramodal system.



Figure 8. William Norman McAnge, as sketched in the *Atlanta Constitution*, September 7, 1890.

Throughout Pollock's celebratory book are printed advertisements for Suffolk's principle businesses. Among them is a broadside for W. N. McAnge's oyster house (Figure 13). Oyster packers of the 1860s and 1870s principally canned shucked oysters in tin cans or buckets for shipment. While popular, the oysters were of the preserved variety and lacked the fresh taste desired by consumers. McAnge notably expanded the 'barrel trade' in Suffolk, shipping live oysters in iced barrels for the fresh market. Fresh oysters added a market to Chesapeake seafood packers and likewise provided business for the cooperages of Suffolk, ice shippers, and

the railroads. Oyster shells leftover from the canning process were burned in kilns to make lime for farmers' fields (Figure 15).

McAnge's business shucked, cleaned, canned, iced, and packed oysters harvested throughout the Chesapeake Tidewater region. The process of canning oysters involves steaming, shucking the meats, washing them to remove grit, grading for size and then packing in hot brine. The constant need for heat resulted in two fires in McAnge's oyster house on the south side of the river. In both cases, McAnge was on-hand to help fight the fires. While neither fire debilitated the structure or business, it provides insight that the owner was on site and involved with the daily operation of his business.

In 1889, McAnge added to the main plant, including an additional boiler, to assist in canning operations (Figure 9). In 1894, he converted a building to the south to a canning facility (Sanborn Map Company 1894). One newspaper noted that "it was very seldom an oyster remains in his packing house over a day" (*Herald and Tribune* 1885:3). In 1898 oyster holding pens ("floats", Figure 10) were installed to store live oysters on site, allowing McAnge to claim he had "the freshest oysters throughout the Chesapeake" (*Yorkville enquirer* 1891:4).

By 1904, McAnge's operation shifted to the northern side of the Nansemond River west of Smithfield Street. A 'Bird's Eye View of Suffolk' published by Thaddeus Fowler in that year shows an active waterfront on the north bank, including a smokestack likely serving McAnge's limekiln (Figure 11). While buildings appear on the southern side of the river, they do not appear as fish houses. By 1920, a lumber mill and yard occupied the site of McAnge's first establishment. The reason for moving the operation is unknown but land on the north bank has more level, open ground for expansion. That on the south bank, to the west of Main Street, includes a steep bluff requiring significant cut and fill for expansion.

McAnge's business continued to grow to meet the demand of his buyers. At peak production in 1900, he leased 300 acres in the Nansemond River and Poquoson Flats (Hotchkiss 1899:1012). While local oyster sales undoubtedly formed a significant portion of his

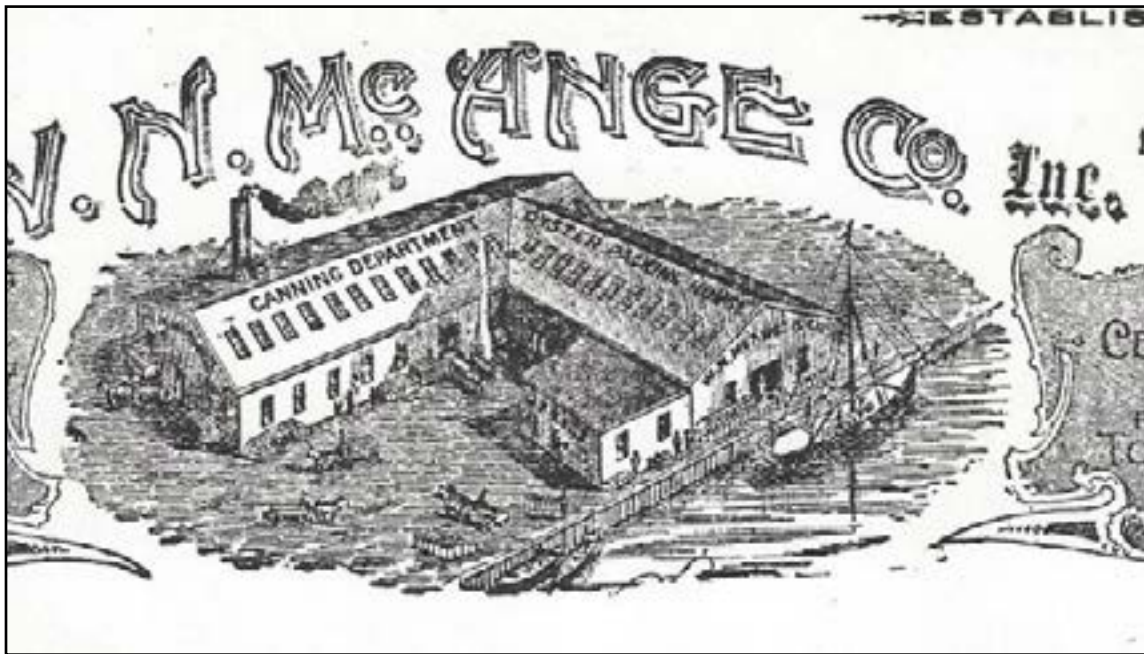

Figure 9. Detail from an advertisement for McAnge's oyster house showing the post-1889 expansion to include a larger canning room.

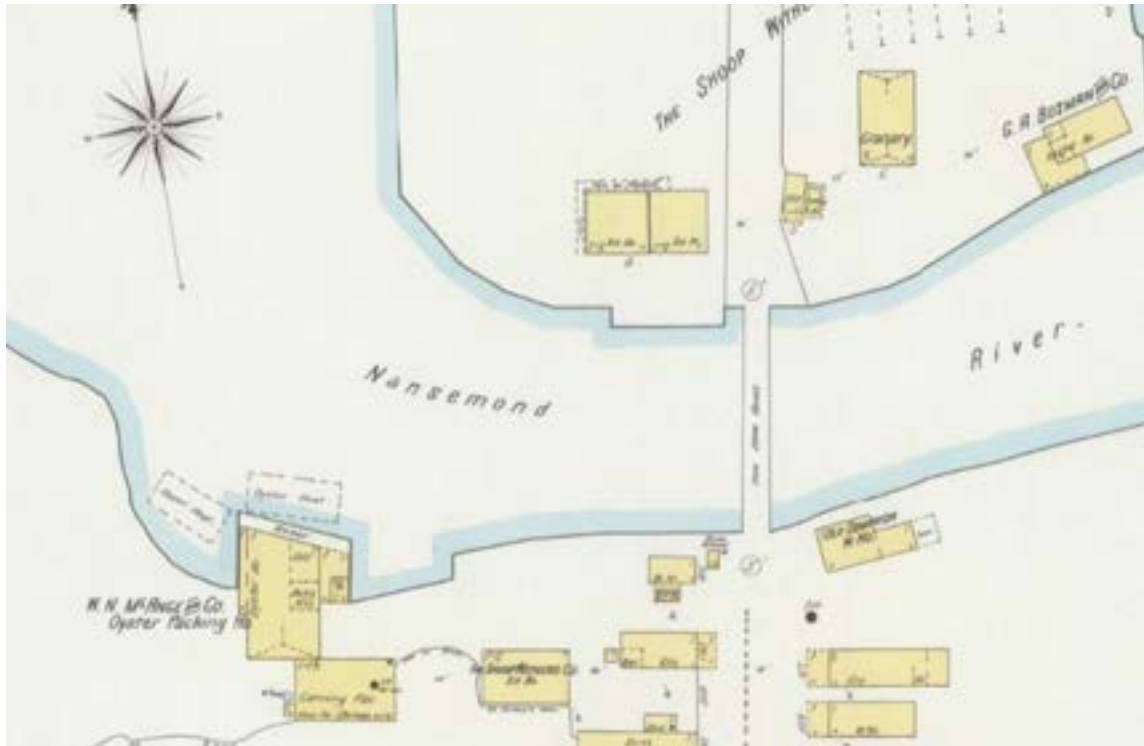

Figure 10. An 1898 Sanborn Fire Insurance Map depicting McAnge's oyster house, wharf, canning plant, and limekiln. Note the Shoop Withers Co., which provided ice to McAnge's operation. Oyster floats are also seen in the river, to hold live oysters for shipment. (Library of Congress)

sales, McAnge shipped "more fresh oysters to the South and West, through the great territory between Chicago and New Orleans, than any other man in the States" (Hotchkiss 1899:1012). Pollock (1886:110) attributes McAnge's success to the fact that he not only owned the oyster house but his own fleet and oyster leases (Table 1 and Figure 12). The fleet allowed him to continually fish and trans-

port merchandise throughout the Chesapeake Tidewater region (Figure 13). It appears that McAnge also operated an oyster operation in North Carolina and was involved in the New Jersey scallop fishery. Numerous ocean scallop (*Placopecten magellanicus*) shells may be seen on the south bank, an indication that some of McAnge's fleet sailed between New Jersey and Suffolk.

Figure 11. Detail from a 1907 "Bird's eye view of Suffolk, Virginia" showing commerce on and around the Nansemond River. Note the distant chimney, likely the limekiln for W. N. McAnge's oyster lime factory. The working waterfront and oyster house is further to the left with a docked fleet. (Library of Congress)

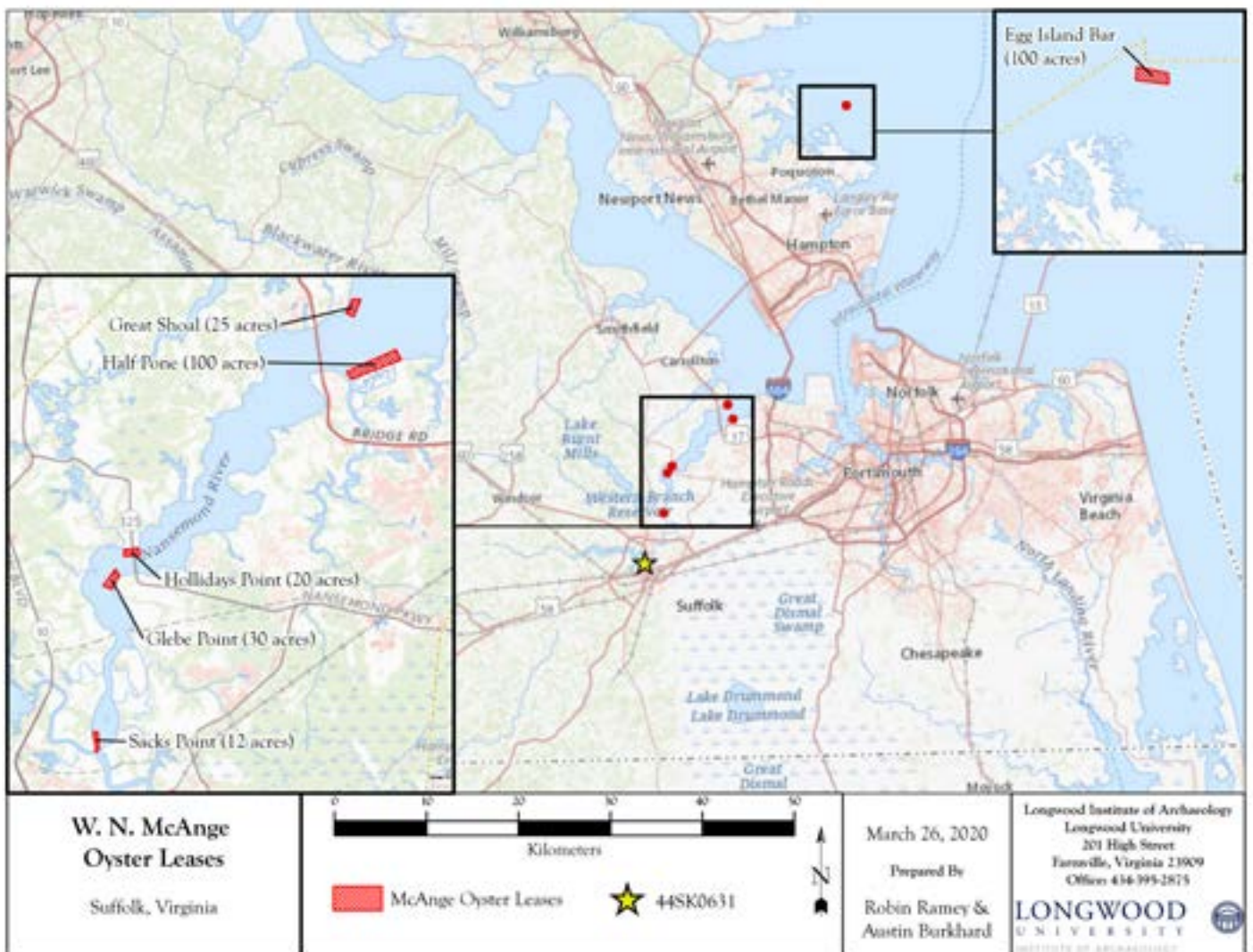
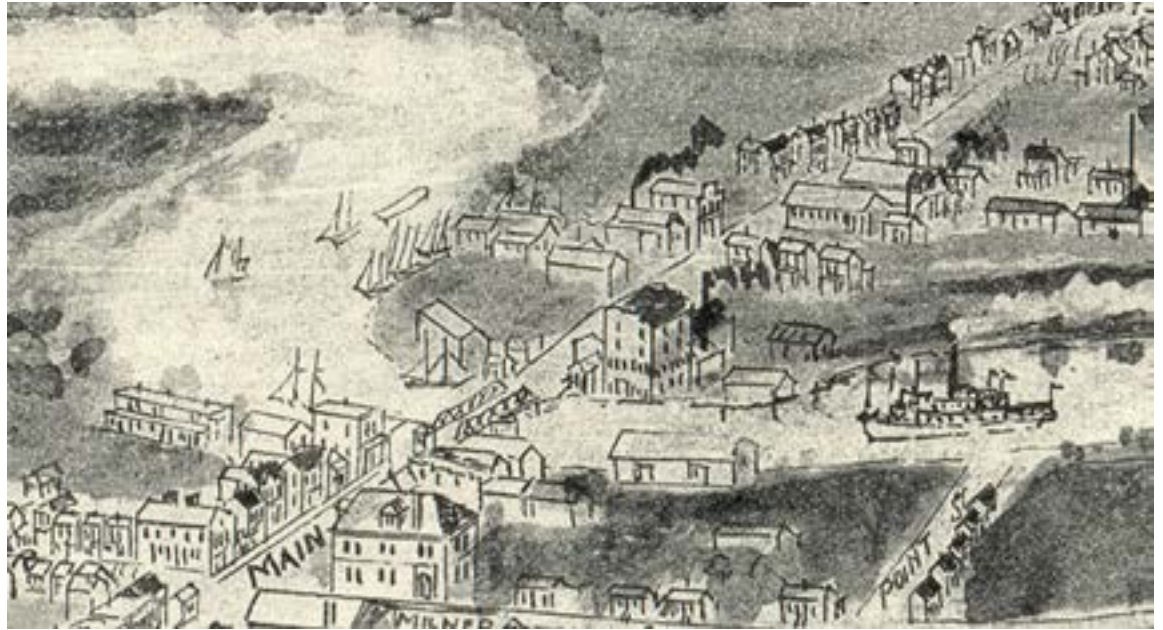

Figure 12. Oyster leases owned by W. N. McAnge Oyster Company.

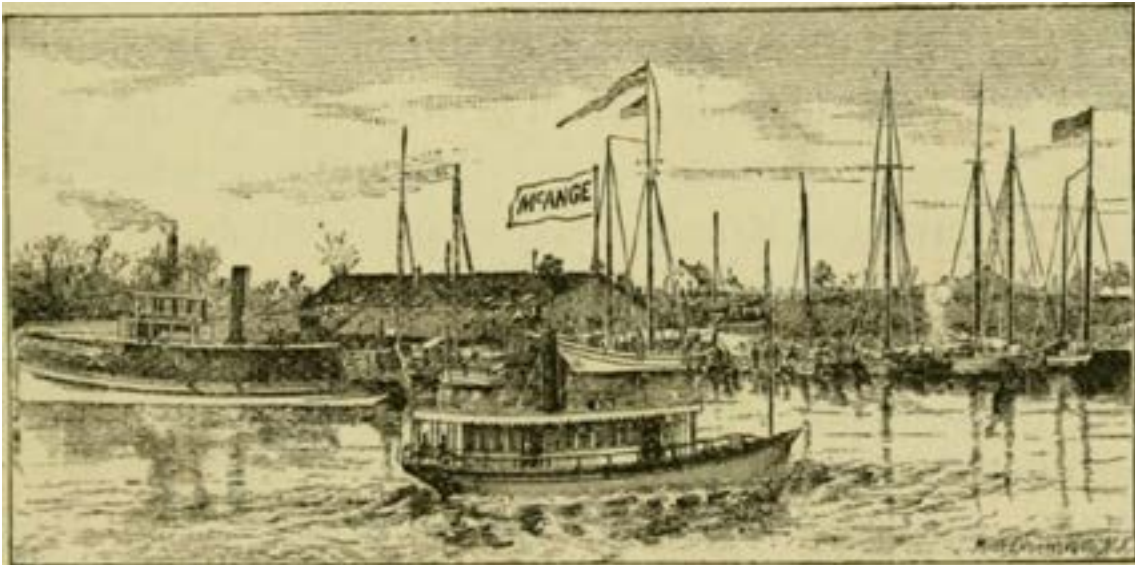

Figure 13. This image, published in Edward Pollock's 1886 Sketch Book of Suffolk, depicts the oyster house and fleet operated by William Norman McAnge and a diverse array of vessels on the river.

Vessel Type	Name	Length/Breadth (ft)	Capacity GT/NT (Bu)*	Notes	Official Number
tug (steam)	<i>Alein</i>			Was noted in 1890 Atlanta Constitution, Alein is the middle name of W. N. McAnge's wife.	
barge	<i>Washington</i>		?/250 (5,000)		
barge	<i>Pirate</i>		?/125 (2,500)		
schooner	<i>Maltby</i>		?/50 (1,000)		
schooner (gas)	<i>W. N. McAnge</i>	40 x 15.6	?/40 (800)	Built 1899 in Suffolk, Va. Converted to gas engine by 1909.	81860
sloop	<i>A. K. Tiller</i>		?/17.5 (350)		
sloop (gas)	<i>Peter Smith</i>	36.6 x 12.4	?/17.5 (350)	Built in Suffolk, Virginia. Converted to gas by 1908	150736
schooner	<i>Louise</i>				
sloop (gas)	<i>Sure Thing</i>		?/20 (400)		
sloop	<i>Edna B</i>	36.9 x 11.8		Built 1891 in Suffolk, Va.	136226
unknown	<i>Aileen</i>			Repaired by boatbuilders in Crittenden, Virginia in 1929. Noted as an oyster boat.	
schooner	<i>Eliza Ann</i>	40.6 x 15.3	16.88/16.04	Noted in 1895 Norfolk Virginian. Capt. Smith.	137801

Table 1. Listing of known vessels owned by W. N. McAnge Oyster Co. *U.S. Customs House tonnage calculations allowed 20 bushels of oysters to 1 net ton (Brewington 1963:115).

SHELL LIME **ALWAYS RESULTFUL**

YOUR LAND NEEDS GOOD LIME

McAnge Agricultural Lime
 is made from Oyster Shells and is far superior to Rock Lime. By actual test it has proved to be the Highest Grade Lime made.

McANGE LIME sweetens acid soil quickly, and increases the yield. It spreads easily because it is ground as fine as flour, and always dry. Thousands of farmers testify that **McANGE'S LIME** increased their crop yield from 30% to 50%. Sold only in new strong sacks; an inexpensive crop producer. Write today for price. **Clip the Coupon.**

W. N. McANGE CO., Dept. D, Suffolk, Virginia

Coupon—Cut Out and Mail Today

W. N. McANGE CO., Dept. D, Suffolk, Va.
 Gentlemen:—Please quote lowest price on your lime.

Name _____

Address _____



Figure 14.
 Advertisement from
 the North Carolina Christian
 Advocate, March 14, 1912 for
 McAnge's Agricultural Lime,
 produced as a byproduct of
 the oyster business.

110 SKETCH BOOK OF SUFFOLK, VA.

W. N. McANGE,
 SUFFOLK, VA.

PLANTER, PACKER AND SHIPPER OF

FRESH OYSTERS

PACKED IN EVERY STYLE
 AND SHIPPED IN ANY QUANTITIES FROM ONE
 TO ONE THOUSAND GALLONS.

Facilities Unsurpassed in Virginia.

44,000
 Bushels Fine Old Plants on My Own
 Planting Grounds.

The Express and Railroad Company's books show that I ship three-quarters of the entire Bulk of Oysters shipped from this point. I OWN MY OWN VESSELS AND PLANTING GROUNDS, thus giving my customers oysters direct from their native beds and guaranteeing them a full supply in all kinds of weather.

Correspondence Solicited. No trouble to answer letters.

W. N. McANGE,
 Foot of Main Street, Suffolk, Va.

Figure 15.
 Advertisement for
 the McAnge Oyster
 Company published
 in Edward Pollock's
 Sketch Book of Suffolk
 in 1886.

SURVEY RESULTS

Bankline and foreshore survey during low tide on September 30, 2019 indicated the presence of at least twelve historic watercraft. Additional work during the October 2019 expedition revealed another submerged vessel associated with the Funkhouser Fleet and possibly one submerged vessel in the northeastern portion of the site near the east bank. Each vessel, cluster of vessels, architectural component, or other historic attribute was recorded as a feature within a multicomponent site. Fifteen features have been identified. Temporal association of the site places it between 1860 and 1945. Site features are discussed here as individual but contributing elements to the overall Nansemond Ghost Fleet.

Feature 1: Pilings

Heavy pilings and a wharf structure were identified on the September 30 canoe survey (Figure 17), on the north/east bank of the river. Forming a T-headed wharf, this structure may relate to a mid-20th century fuel dock constructed and operated by the Standard Oil Company. Dolphins (numerous pilings driven together and lashed as one fender piling) appear to the north and south of the wharf face, forming a length of approximately 20 meters. This structure is consistent with wharf infrastructure built to handle liquid-carrying barges. Since only a small portion of a fuel barge necessitates access to load or

unload, smaller wharves may be constructed. Sanborn Fire Insurance maps show a fuel platform built out into the river by 1921 (Figure 18). The wharf appears to have been abandoned for some time.

Feature 2: Unidentified Vessel Remains

Feature 2 is located on the north/east bank of the Nansemond River approximately 114 meters south of Feature 1. The feature consists of wooden vessel hull fragments that appear to come from at least two vessels. Rounded stones, possibly ballast, overlay some of the hull remains. Vessel remains indicate a curved bottom planked vessel with sawn frames (Figure 19). Observations along the waterfront near Feature 2 indicate infill of the riverbank. The practice of placing abandoned vessels along shorelines and filling them with spoil to create land is widespread. Vessel remains act to stabilize soil

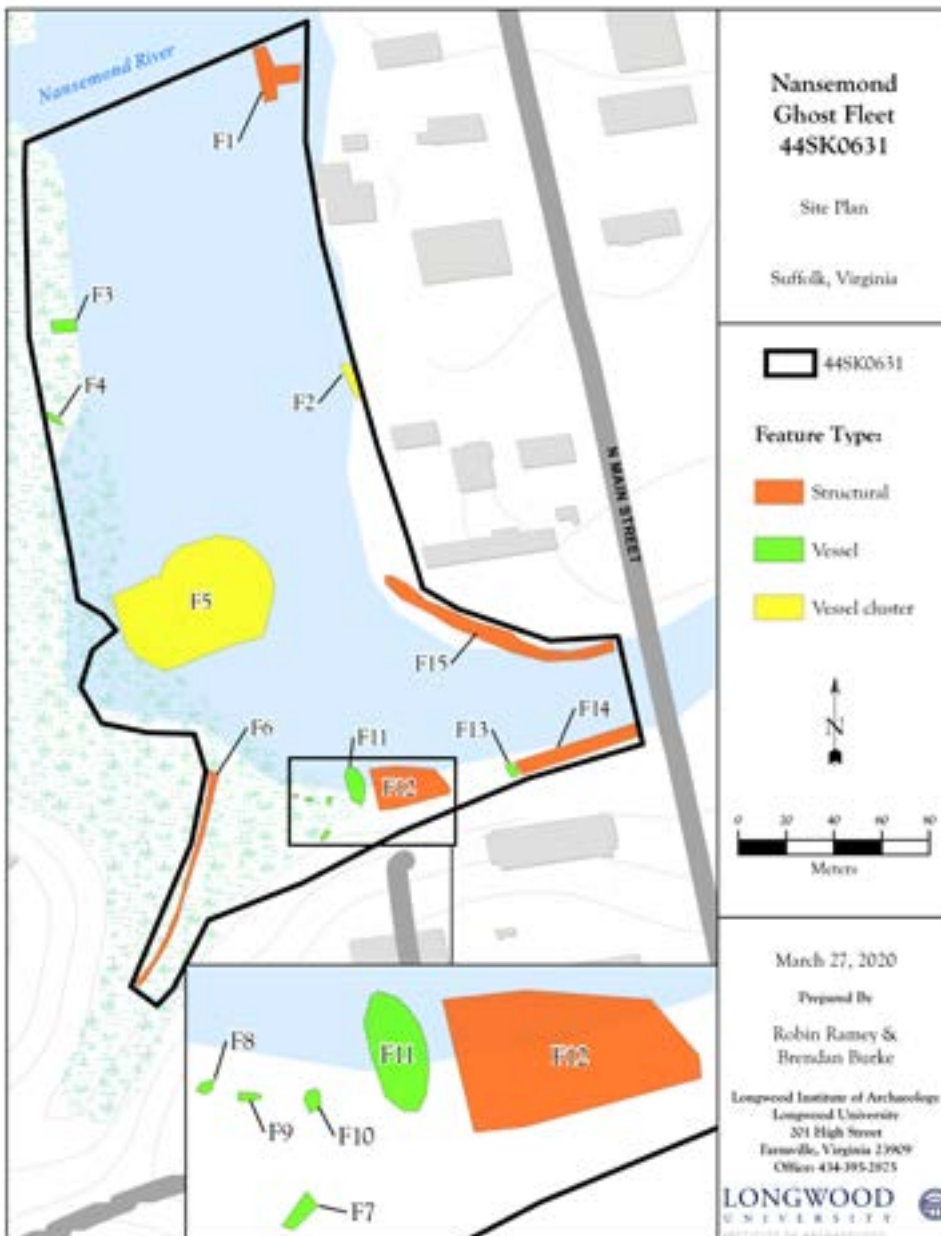

Figure 16.
Features identified within 44SK0631.



Figure 17.
Feature 1 as it appears in
2014 Google Earth aerial
imagery.

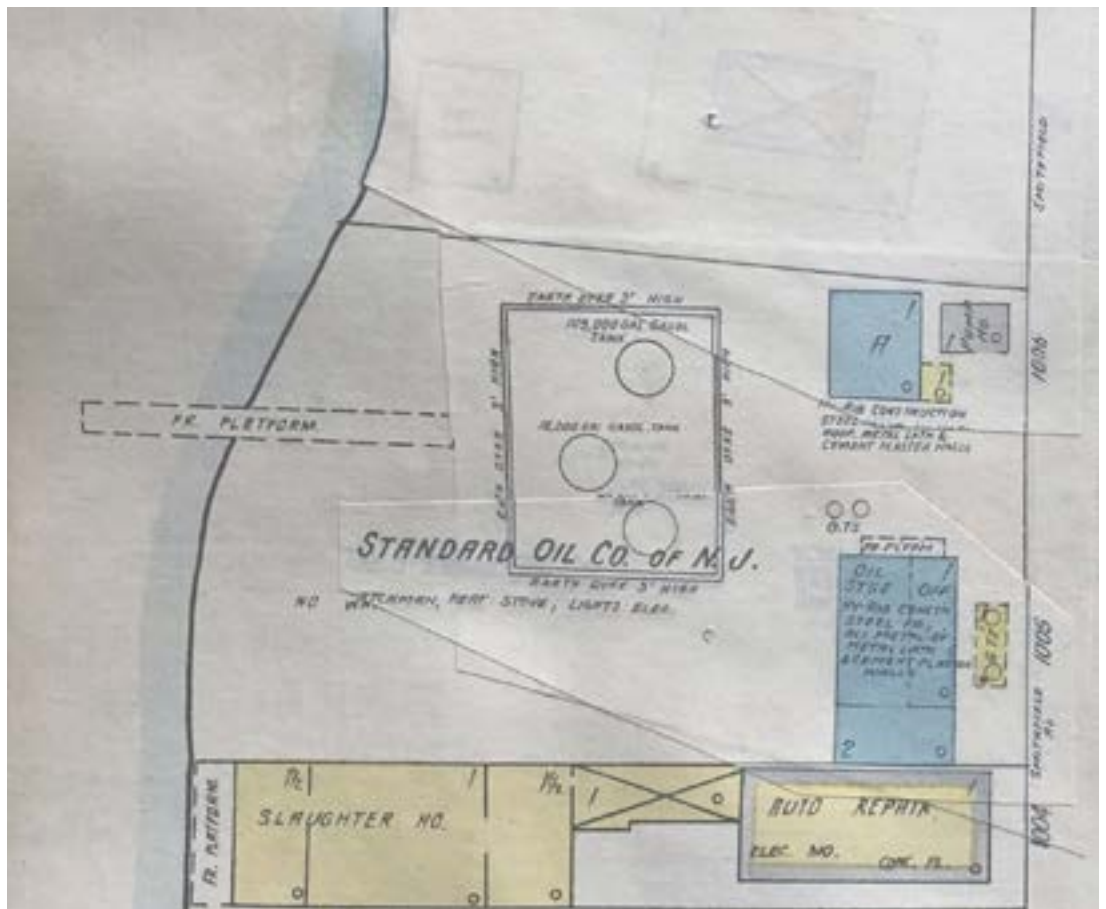
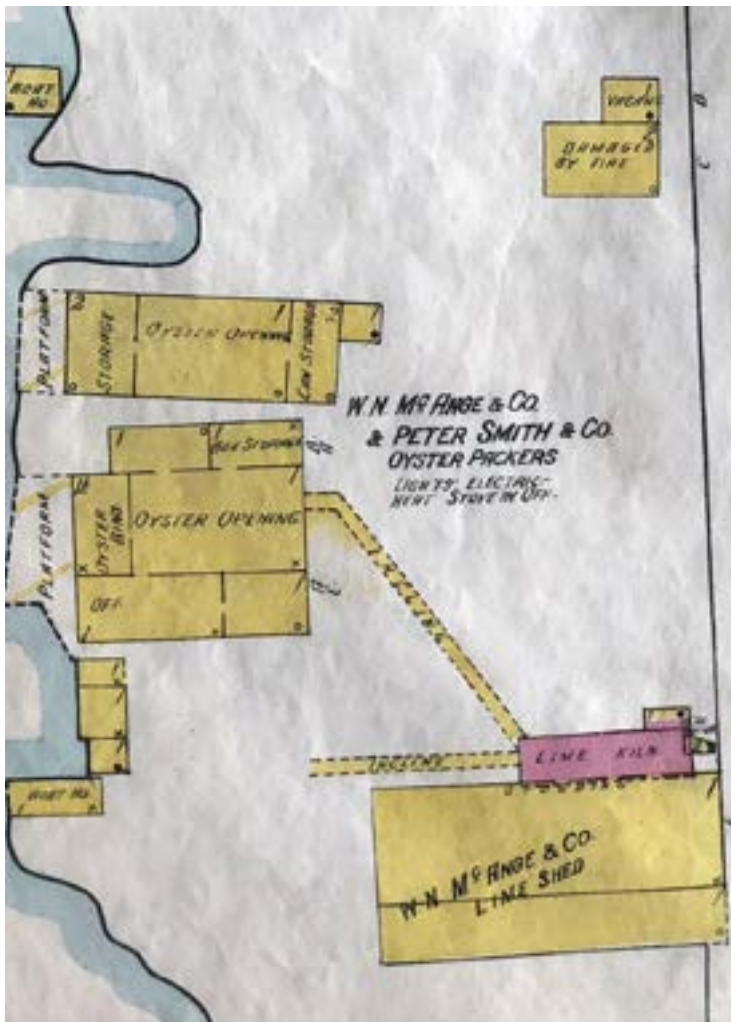

Figure 18.
Inset of the 1920
Sanborn Fire Insurance
map showing a frame
platform extending into
the river. Note tankage
built to handle barge-
delivered gasoline. The
wharf structure appears as
original on the 1920 map
but the tank farm and
associated buildings were
constructed subsequently
and may be seen as
pasted-in amendments to
the 1920 map. (Courtesy,
Suffolk Nansmond
Historical Society)



Figure 19.
Feature 2 vessel remains.



along waterfronts and the practice is a convenient way to dispose of abandoned craft.

The area surrounding Feature 2 was occupied by two oyster houses operated by W. N. McAnge (southernmost) and Peter Smith during the 1920s (Figure 20). The McAnge oyster house was connected to a limekiln located southeast of the oyster house and fronting Smithfield Road, modern day Business 460. Sometime after 1910, McAnge moved his oyster house and limekiln from its original location on the south/west bank of the river to this place. It is possible that builders hauled the older, derelict boats onto the bank and covered them with fill dirt to create a footing for the oyster house complex. Feature 2 resides on private property that, at time of survey, was for sale. The research team could not establish contact with the owner and, without permission granted to enter the property, investigators made no detailed drawings or measurements.

Figure 20. Oyster houses operated by W. N. McAnge and Peter Smith shown on the 1920 Sanborn Fire Insurance map. It is assumed that the southern oyster house belonged to McAnge since it is connected to a limekiln of the same name. (Courtesy, Suffolk Nansemond Historical Society)



Figure 21.
Feature 3, remains of a
small wood barge.

Feature 3: Barge

Barges are probably the most ubiquitous type of historic watercraft. Feature 3 represents a wooden barge measuring approximately five by three meters. The barge is the northernmost vessel identified in the site and resides on the western bank. During normal tidal cycles, the barge remains are mostly submerged with the exception of one segment of hull (Figure 21). The feature was documented remotely due to the depth of mud surrounding vessel remains and limited low water during the October field phase. Further examination and documentation of this feature is recommended.

Feature 4: Double Ended Skiff

Feature 4 is a double-ended skiff measuring approximately five meters long. The skiff had mud around it too deep to safely negotiate, and the vessel lies mostly below the low tide line. Photo and sonar imaging were the primary means of documentation. On one occasion, the field crew was able to hover over the Feature 4 boat from a canoe and observe construction elements (Figure 22). Shipwrights built the skiff of planked sides, a flat bottom, and raked ends. Side planking remains in place but the stem and sternpost appear to have rotted away where the vessel is exposed. Framing could be felt inside the vessel and bottom planking appeared to be fore-and-aft

but should be re-checked. M. V. Brewington documented a similar skiff in Wenona, Maryland in 1941 (Figure 23).

Throughout the Chesapeake Bay and its tributaries, people used such skiffs for transportation, crabbing, fishing, and sport. Lightly built, double-ended skiffs emerged as replacements for dugout canoes since they could be fashioned from common sawn lumber (Fleetwood 1995; Parker 1994). The double-ended skiff is one of several double-ended hull types endemic throughout the Chesapeake region. Other types of double-enders include the Hooper's Island sharpies, bugeyes, log sailing canoes, Petersburg boats, and brogans.

Feature 5: Funkhouser Fleet

Feature 5 is the most complex area of site 44SK0631. A portion of the site is believed to be owned by the Funkhouser family, who granted access permission to their property from the water. The feature consists of at least six wooden vessels and appears to form a vessel abandonment area on the outside bend in the Nansemond River where the channel turns to the north. This area is presently a muddy foreshore adjacent to canebrake marsh. Timbers protruding from beneath the canebrake root structure, where eroded, indi-



*Figure 23 (above).
In this 1941 photo by M. V. Brewington a double-ended skiff is shown out of the water. A trunk appears in this skiff, indicating it was rigged for sailing. (Courtesy, the Mariners' Museum)*



*Figure 22.
Feature 4, a double-ended skiff seen in the foreground.*

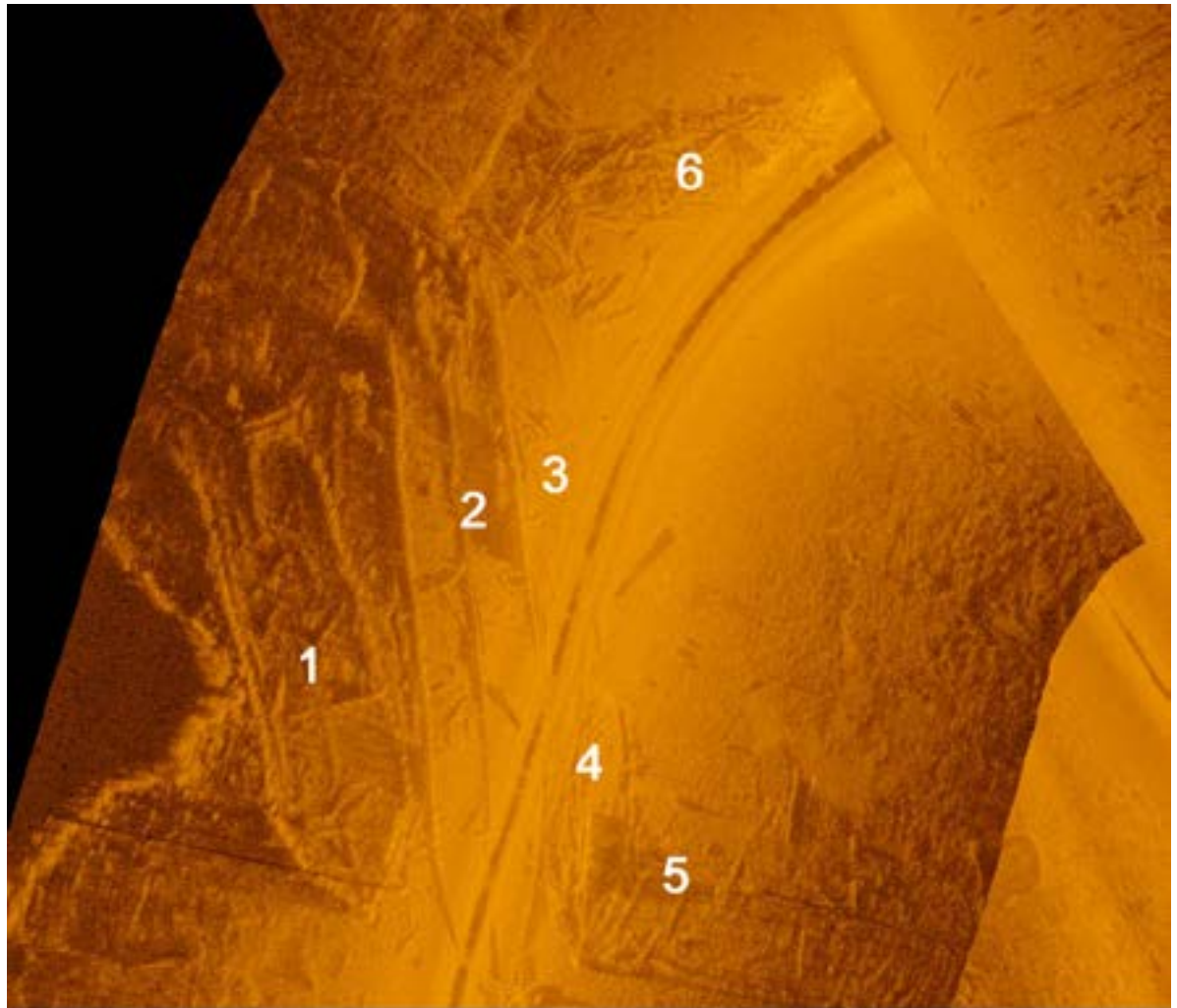

Figure 24.
Feature 5, the
"Funkhouser Fleet"
as viewed by side-
imaging sonar.
Vessels 3 and 5
are barely visible
in this image, only
frame ends and few
planks are exposed.



Figure 25. Feature 5, the "Funkhouser Fleet." Kermit Hobbs shot this photo during the initial documentation of the Nansmond Ghost Fleet in 2017. It captures an exceptionally low tide and the remains of six vessels.

cates that this area was not marshland during the 19th and 20th centuries. A large diameter piling, located between the bows of vessels 1 and 2 was likely placed to moor derelict vessels and prevent them from coming adrift during periods of high water.

Five of the vessels in this feature align roughly north/south and are numbered west to east accordingly (Figure 24). Vessel preservation ranges from good to poor, the larger vessels survived intact due to heavy structural components. Vessel 1 is the highest of the group and is the first exposed during low tide. Vessels 3 through 5 are exposed less frequently and Vessel 6 is very rarely exposed.

Vessel 1

This vessel (Figure 26) is likely a scow barge due to its heavy construction and flat bottom. Its length and breadth are 25.24 m by 6.72 m. Extant structural components include framing, a stem, cutwater, transom framing, chine logs, and a rider keelson. It shows crude construction throughout and all fastening observed was of iron, including chisel-tipped spikes. Planking and framing appeared to be cut from unidentified soft wood. The keel structure was

comprised of heavy timbers set up in a traditional keel, keelson, and possible keelson-rider arrangement. Probing of the mud around the central structure did not indicate the presence of sister keelsons or a centerboard trunk.

Vessel 1 is heavily framed and, with the exception of cant frames comprising the stern, frames appear to be plumb (Table 3. Vessel 1 scantlings). Patterning of good-condition frames alternating with very poor condition frames indicate sister framing throughout (Figure 27). Curvature of the bow was minimal and took on a primitive appearance of a nearly triangular bow attached to perpendicular sides. Initially, investigators thought that the bow had deformed in the process of rotting and falling apart but a chine log indicated otherwise. On the port side a heavy chine log, nearly square in profile, was fastened to the interior of the frames. The log ran out at the turn of the bow and was relieved to fit the inward curve of the bow. Probing mud inboard of the chine log found a flat bottom, likely ceiling timbers, although the presence of thousands of fragments of wood contained within the mud prevented reliable probe data.



Figure 26. The bow of Vessel 1 of Feature 5, the Funkhouser Fleet. Note the piling on the port side of the bow, likely placed to keep the derelict vessels from coming adrift, hitting the bridge, or blocking the channel. Also note the chine log on the port side; it appears to run out at the break in the bow. A single heavy timber spiked to the top of the keelson may have served as part of a mast step. (Courtesy, the Fairfield Foundation)

Vessel Component	Molded cm (in)	Sided cm (in)	Notes
frame	11.6 (4.5")	15.24 (6")	
stem	37.46 (14.75")	n/a	
keelson	27.94 (11")	30.48 (12")	estimated via probing

Table 2.
Vessel 1 scantlings.

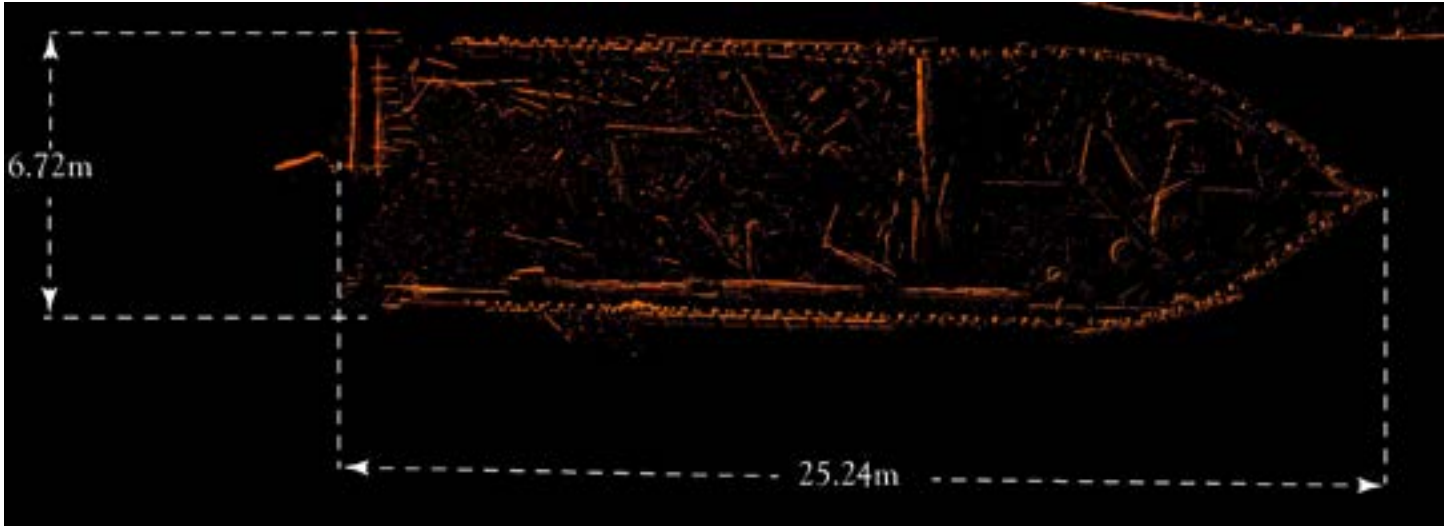

Figure 27. Laser point cloud data of Vessel 1 and 2 showing the keelson, framing, and cant frames. Ceiling planking is seen in the portside planking. Note doubled frames with an alternating pattern of good/poor preservation.

Vessel 2

Moored immediately east of Vessel 1, Vessel 2 is the longest of the Funkhouser Fleet wrecks (Figure 28). Length is 37.10 m and breadth is 5.97 m. Like Vessel 1, this wreck likely served as a scow barge. Although more lightly framed than Vessel 1, it shares similar raked stern framing as its neighbor. Probing the interior mud indicated that this vessel was nearly flat-bottomed, an additional indication of a scow barge. Overall, the vessel is lightly built (Table 4). A vertical keelson, or perhaps rider keelson stands in the centerline but stops several meters short of the stem. Likewise, this timber does not carry fully to the stern. The



Figure 28.
Vessel 2 of Feature 5,
the Funkhouser Fleet.
Note the standing keelson.
(Courtesy of Kermit Hobbs)

Vessel Component	Molded cm (in)	Sided cm (in)	Notes
Frame	10.16 (4)	12.7 (5)	Spacing was 58.42 (23)
Keelson	8.89 (3.5)	n/a	

Table 3.
Vessel 2 Scantlings.

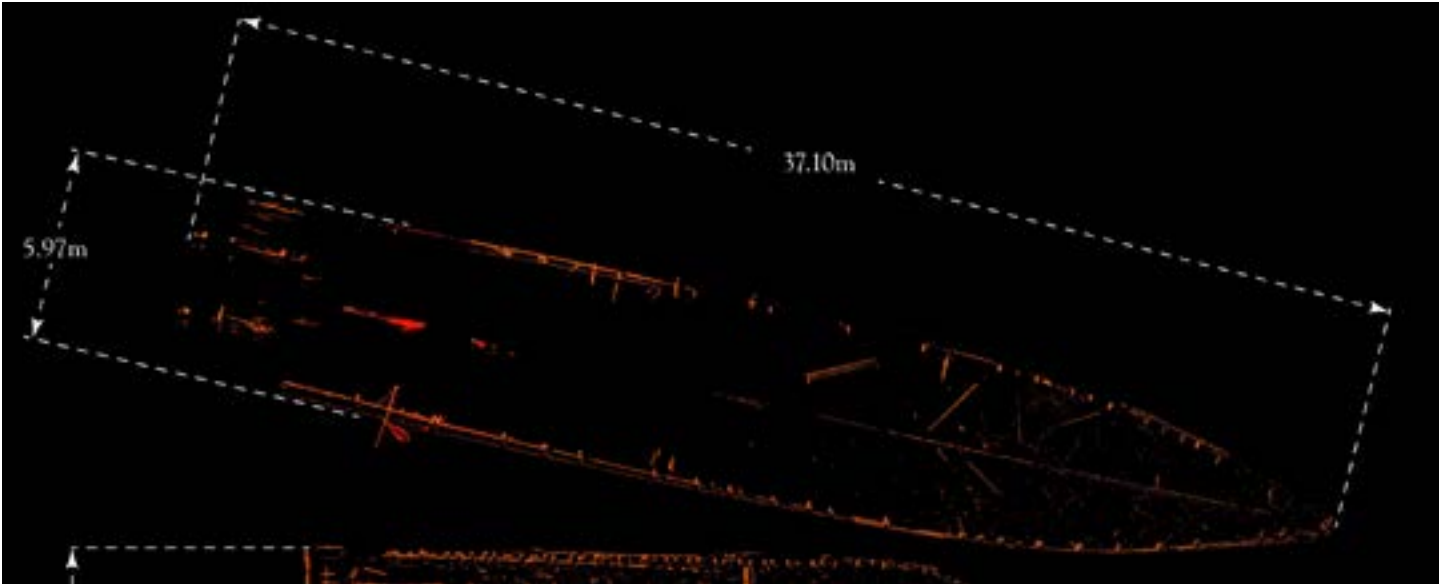

Figure 29. Vessel 2 of Feature 5, the Funkhouser Fleet, seen in laser point cloud. Note the difference in profile from Vessel 1.

profile of this vessel has a much sharper entry than Vessel 1 (Figure 29) and the vessel sides do not become parallel until near the vessel's center. No indication of a centerboard trunk was present. Fastening throughout was iron chisel-tipped spikes approximately 1/2" square.

Planking appeared to be of soft wood, as were frames.

Vessel 3

Vessel 3 appears to be a small barge or floating work platform (Figure 30). Seven heavily



Figure 30. Vessel 3 of Feature 5, the Funkhouser Fleet. Frame ends are exposed in the right-hand side of the picture. (Courtesy Kermit Hobbs)

eroded cant frames are present on the vessel's north end and frame heads appear in a line along the western edge. Probing indicates intact hull structure below the mud but all wood above the mud line is heavily deteriorated. No scantlings were recovered because of the poor condition of the wreck and inability to access the vessel's eastern side due to flooding during the October field phase. The vessel is estimated to be eight-meters long and three meters in breadth.

Vessel 4: Possible Skipjack

Vessel 4 is located immediately to the east of Vessel 2 and to the south of Vessel 3 (Figure 31). The bow section is relatively intact and hull remains extend aft but disappear into the mud at the stern. A centerboard trunk approximately 3.96 meters remains with the centerboard still inside. An iron lifting bridle was observed atop of the centerboard during the June 2019 visit but was not present during the October 2019 field phase. Overall vessel length, approximated due to the lack of a clear transom, is estimated to be 13.75 meters long with a breadth of 4.46 meters.

Vessel 4 has a length-to-beam ratio of roughly 3:1 and forward placement of a centerboard trunk. Additionally, sawn frames appear to be straight sided and spaced consistently with skipjack construction. Probing inside the hull indicates a vessel bottom with low deadrise (Figure 33). Due to mud coverage, no mast steps were identified.

Overall shape and features of Vessel 4 indicate that it was constructed as a Chesapeake Bay skipjack. A type of watercraft unique to the Chesapeake Bay region, skipjacks were designed primarily to serve the oyster industry. Burgess (1963:110) places the skipjack's origins to the 1880s when a boom in the oyster industry required vast amounts of additional fishing tonnage. By the mid-20th century over 2,000 skipjacks had been built for oystering.



Figure 31. Vessel 4 of Feature 5, the Funkhouser Fleet. Construction elements and shape indicate that this vessel may be a Chesapeake Bay skipjack.

Skipjacks were more economical to build and operate than the two-masted, round bottomed bugeyes. Sloop rigged, two men could handle a skipjack to drag an oyster dredge and cull the catch (Figure 32). Like bugeyes, skipjacks were



Figure 34.
Vessel 5 of Feature 5, the Funkhouser Fleet.



Figure 32. The skipjack E. C. Collier on the marine ways in 1988. Built in 1912, the E. C. Collier represents a traditional skipjack. (Courtesy of the Library of Congress)

put to work offseason hauling truck crops such as watermelons, firewood, and other sundry cargos. Today, about thirty skipjacks remain, and in 1985 the skipjack became the state vessel of Maryland. Further documentation of this vessel is recommended.

Vessel 5: Barge

Vessel 5 appears to be a small barge or flat (Figure 34). Approximately 12-meters long and six meters in breadth vertical frames form plumb sides and cant frames form a stern and bow. Probing indicates that only a few inches of this vessel are contained within the mud and much of the hull has eroded away. Further investigation of this wreck is warranted. No original wood surfaces were present from which to gather scantlings or accurate frame spacing.

Figure 33. (Pages 38-39). Lines of the Caleb Jones, a traditional skipjack. Note the low deadrise and forward centerboard trunk. (Courtesy Library of Congress.)

Skipjack *Caleb Jones*

Built by the Rice Brothers in Reedville, Virginia (19

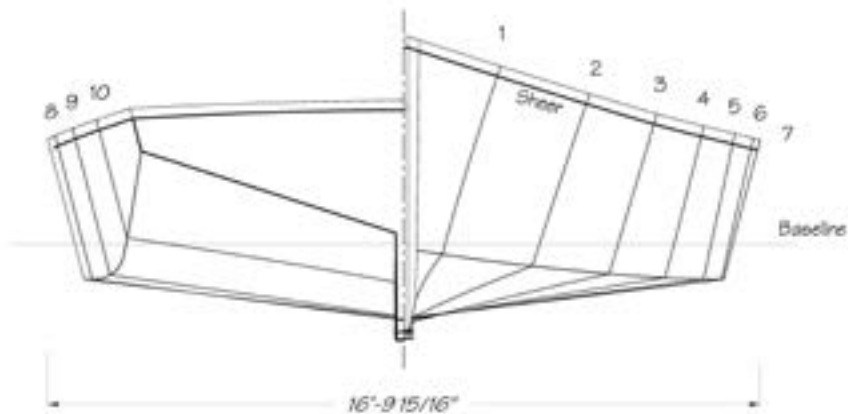

STATIONS		X-POSITIONS
HEIGHT ABOVE BASELINE	SHEER	
	CHINE	
	RABBET	
	SHEER AT STEM: 4-6-2	
HALF-HEIGHTS FROM CENTERLINE	CHINE AT STEM: -0-1-6	
	SHEER	
	CHINE	
	RABBET	
SHEER AT STEM: 0-4-2		
CHINE AT STEM: 0-3-5		

Notes:
Measurements were taken using
Stations offset 4'-0". Drawn

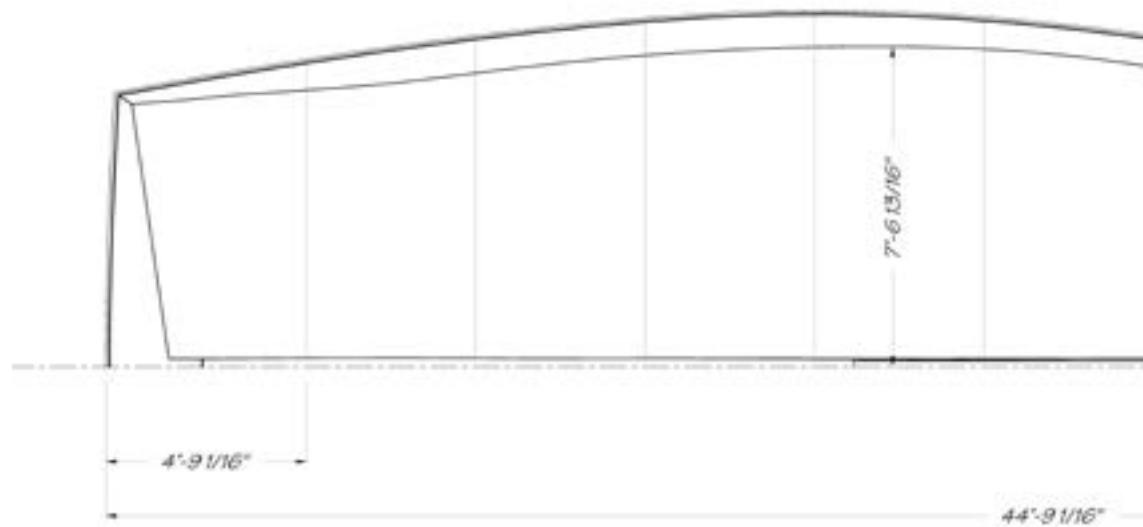
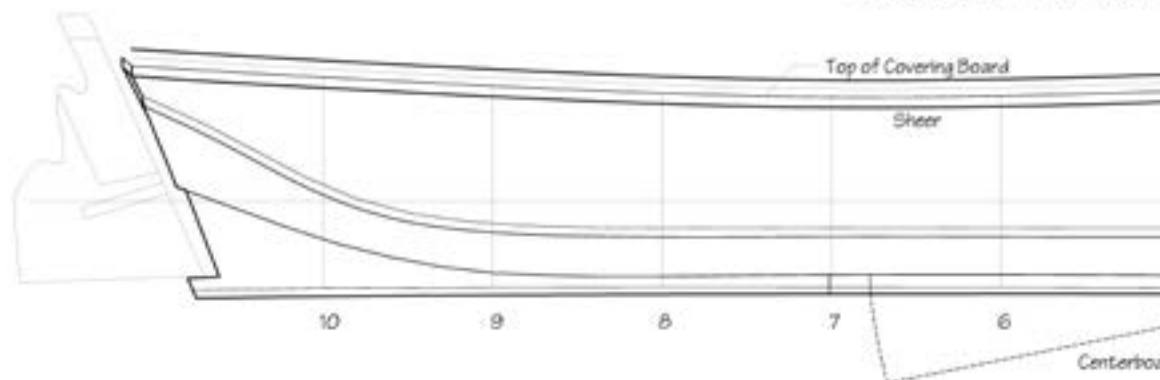

53)

Lines

Scale: 1/2" = 1'-0"

TABLE OF OFFSETS

OFFSETS IN FEET OFFSETS ARE TO OUTSIDE OF SKIN

0.000	1.000	2.000	3.000	4.000	5.000	6.000	7.000	8.000	9.000	10.000
0-0-0	4-0-0	8-0-0	12-0-0	16-0-0	20-0-0	24-0-0	28-0-0	32-0-0	36-0-0	40-0-0
	3-11-3	3-3-6+	2-9-7	2-6-3+	2-4-2	2-2-7+	2-2-5	2-3-5+	2-5-6	2-8-1+
	-0-2-7+	-0-6-2	-0-8-3+	-0-9-5	-0-10-0+	-0-10-0	-0-10-0	-0-10-0+	-0-8-5+	0-1-7+
	-1-4-2+	-1-8-4	-1-10-0	-1-9-3	-1-8-7+	-1-8-6	-1-8-6+	-1-9-2	-1-8-2	-0-10-6
SHEER AT TRANSOM: 2-11-4										
CHINE AT TRANSOM: 2-2-7										
	2-2-3+	4-3-5	5-10-5+	6-11-7+	7-8-6+	8-2-1	8-3-7+	8-1-6+	7-8-7	7-2-1
	0-10-7	3-0-3	4-10-1	6-2-0	7-0-7	7-6-0+	7-6-5	7-4-2+	6-11-2	6-6-3+
	0-3-2	0-3-0+	0-2-4	0-2-4	0-2-3+	0-2-3	0-2-3	0-2-3+	0-2-4	0-2-4
SHEER AT TRANSOM: 6-4-6										
CHINE AT TRANSOM: 6-2-4										

measured with a Leica "Total Station" and developed in AeroHydro MultiSurf Software.
Accuracy is +/- 1/2"

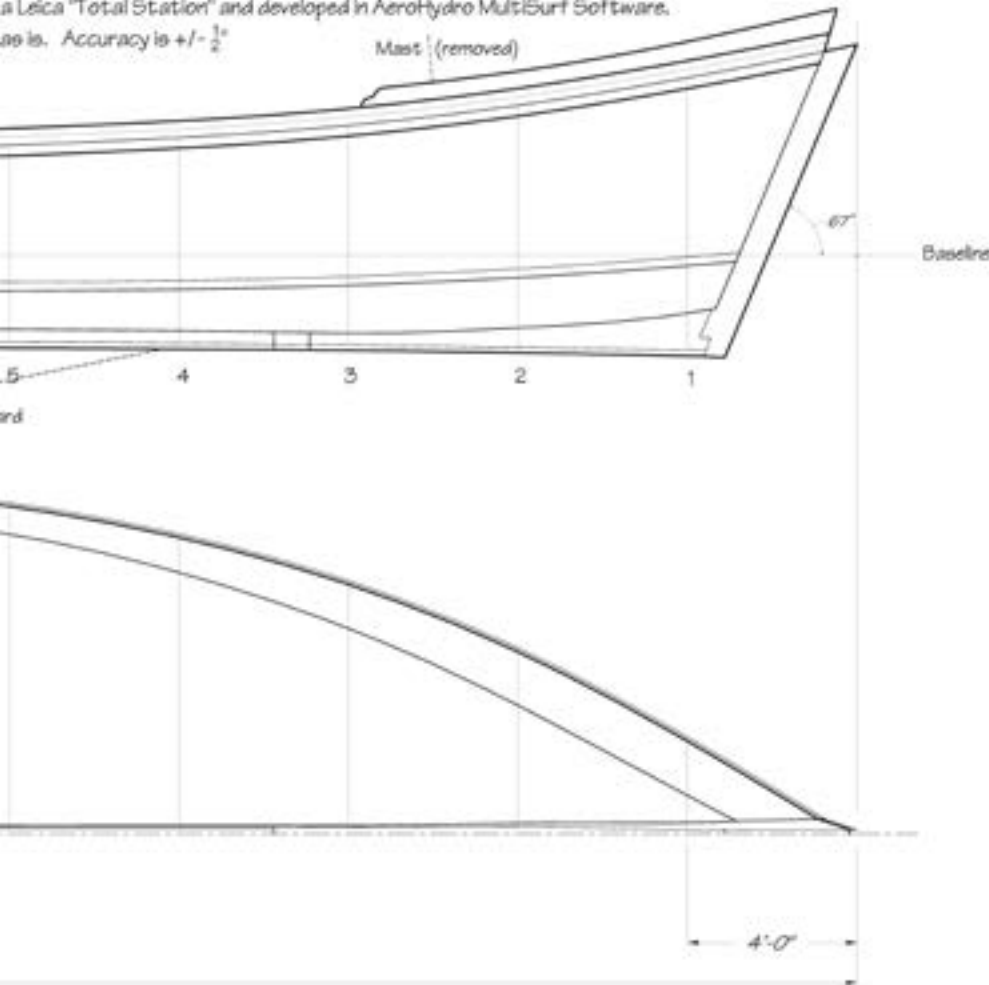

SCALE: 1/2" = 1'-0"

0 1 2 3 4 5 FEET
0 50 100 150 CENTIMETERS

SKIPJACK "CALEB JONES" - 1953
LINES TAKEN AT CHEESAPEAKE BAY MARITIME MUSEUM

ST. MICHAELS
TALBOT COUNTY

DELINEATED BY: TODD A. CROTEAU, 2009
MARITIME RECORDING PROGRAM
NATIONAL PARK SERVICE
UNITED STATES DEPARTMENT OF THE INTERIOR

SHEET 1 OF 3
MARYLAND
HISTORIC AMERICAN ENGINEERING RECORD
MD-171



*Figure 35.
Vessel 6 of Feature 5,
the Funkhouser Fleet.
View is from bow to stern
and generally to the east. Note
the stem in the foreground,
keelson, outer planking,
and engine in the background.*

Vessel 6: Possible Oyster Buyboat

Vessel 6 was originally identified as a possible feature from the Hobbs drone video of 2017. It is the lowest of the vessels yet identified in the Funkhouser Fleet, and thereby contains the best level of preservation and is exposed only rarely by low tides. The vessel was recorded via side imaging sonar during the October 2019 field phase. Oriented roughly east-west, Vessel 6 was abandoned as a powered vessel, the only example from the Funkhouser Fleet. On March 10, 2020, an exceptionally low tide exposed much of Vessel 6. Surviving hull remains measure approximately 14-meters long and four-meters

wide. The bow of this vessel is oriented toward the west about 257° true. A low tide never exposed the stern for project archaeologists to document, but limited exploration by feeling around in the stern area and corresponding sonar data indicate that this vessel was built double-ended or with a rounded transom.

Sonar data indicated the presence of an engine on the wreck, which was confirmed during the March 10 site visit (Figure 36). The engine sits approximately 2.5 meters ahead of the stern and is a three-cylinder oil or gas engine likely

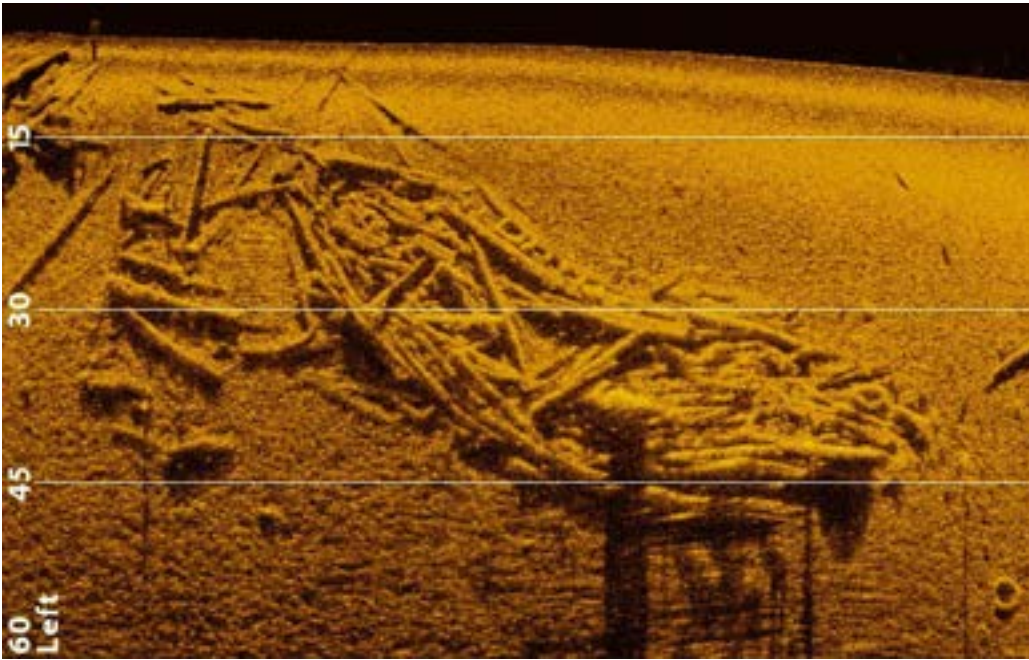

Figure 36. Vessel 6 of Feature 5, the Funkhouser Fleet. Side imaging data gathered on October 12, 2019, during a period of unusual high water, first identified this vessel. Range lines on the image are in feet.



Figure 37. Three-cylinder engine on Vessel 6 of Feature 5. Note the flywheel, facing forward on the vessel.

manufactured prior to 1930 based on the style of casting an air space between each cylinder.

The low tide exposure in March 2020 revealed framing on the starboard side, indicating a vessel built with a rounded bottom. The keelson and stem were visible as well as outer hull planking. A scatter of planks and timbers indicates that upper portions of the vessel have survived, although no longer articulated as structure. Rig and equipment components also indicate the nature and use of the vessel. A braking component of a winch, a deadeye with iron stop, and a possible mast step near the bow of the vessel may point to the boat having

been built or repurposed as an oyster buyboat. Overall length for Vessel 6 is approximately 14.4 meters with an estimated beam of 4.20 meters. Measurements for this vessel were taken from sonar data.

Feature 6: Creek Pilings

A small creek enters the Nansemond River immediately south of Feature 5, the Hobbs Site. A continuous row of small pilings, visible during low tide, lines the west bank of the creek and indicates historical use of the creek. Pilings appear to be small trees, approximate-

ly 10-20 cm in diameter, driven into the creek bottom to form a line of almost-solid wood. It is likely that the small nature of the pilings and close spacing represent bulkheading for some historic landform now eroded away. Historic maps or documents have yet to be located that indicate who erected the bulkhead, or who utilized the landform. Today, land behind the row of pilings is soft mud and canebrake. Sonar imagery of the creek bottom did not indicate the presence of extant materials within the main channel of the creek.

Feature 7: Logboat Hull

During a tree survey performed by Byron Carmean in 2015, a portion of a log boat hull was discovered washed up onto low-lying land adjacent to the Nansemond River. The exact location of the log boat was not recorded at the time and in 2017 local citizens recovered the log boat to Riddick's Folly, a nearby museum for preservation. This feature, while not presently lying within the boundary of 44SK0631, is a contributing element to the site and a reasonable estimate of its 2015 location was added to the site feature map.

Bob and Mary Hayes recorded the log boat as part of the Mid-Atlantic Log Boat Survey, a project undertaken by the MHC and funded by the Institute of Nautical Archaeology (INA). Overall remains of the log boat measure 4.44-m long by 0.88-m wide.

Feature 7 represents a classic example of a log-bottomed vessel unique to the Chesapeake Bay. A hole bored through the stern wood exits the lower-portion of the wineglass transom. Fastener holes adjacent to the main hole indicate the installation of a

stern bearing for a propeller shaft (Figure 38). Moran (2014:35) indicates that boatbuilders constructed powered log-bottomed deck boats during the first quarter of the 20th century, and it is possible that someone converted this vessel to power. The Feature 7 boat contained at least three logs, iron pins, or pin holes that are present on the ventral faces of the center log. Joinery for log boats frequently employed this method of fastening logs to each other. The pins prevented lateral and vertical movement while floors or half frames on the interior fastened logs together. On some smaller vessels, pins alone held the log bottoms together.

Termite, wet rot, and other damage to the hull remains leave little to measure from the original construction. A small section of second, or "garboard," log remains amid ship on the



*Figure 38.
Feature 7, the keel log of a
log-bottomed boat found near the
Nansemond River. It now resides
at Riddick's Folly Museum.
Note the hole drilled for
a propeller shaft.*

starboard side. Corrosion product from the pin likely helped preserve the section of wood.

The Mid-Atlantic Log Boat Registry maintains a full recording of this vessel. (See *Appendix 6* for more information.)

Feature 8: Wooden Vessel

The Feature 8 vessel was one of three small boats partially exposed in the intertidal mud immediately west of Feature 6, the Hobbs Wreck. This boat consists of a keelson and five portside strakes (Figure 39). The forward edge of the keelson includes a copper-alloy through bolt likely used to fasten the stem to the forward edge of the keelson. Degradation to wood surfaces prevented accurate dimensional measurements but the keelson was estimated to

be 13 cm sided and 5 cm molded. Plank widths varied but thickness was estimated at 2 cm. Copper-alloy screws were present in the planks and indicated frame spacing of approximately 18 cm. The construction of the bow indicates that this vessel may have had a sharp entry and may have been a type of skiff known as the 'Yankee' skiffs, or tenders.

This vessel was likely a small tender or fishing skiff. Many oyster boats towed skiff astern, or carried them on deck, for accessing the shore where a wharf or dock wasn't present. Additionally, a skiff could be used to communicate with another vessel where rafting together was too dangerous. The presence of copper-alloy screws indicated that this vessel was built during or after the late 19th century.



Feature 9: Wooden Vessel

Feature 9 is the bow end of a small wooden boat and includes a keelson, five floors, and three planks (Figure 40). The vessel was constructed with a flat bottom, consistent with skiffs and sharpies of the late 19th century. Probing in the mud to the south of the vessel indicated the presence of additional hull remains. This vessel was not intensively recorded and deserves further documentation.

Figure 39.
The bow section of a vessel is seen here with five strakes emerging from the mud (center and right-hand) with a keelson (left-hand) seen sticking out of the mud with a copper-alloy through-bolt present.

Feature 10: Wooden Vessel

Hull remains comprising Feature 10 appear to be bottom planking and a keelson from a small wooden vessel with low deadrise. The vessel was photo recorded (Figure 43) on October 3, 2019 and a table of offsets (Figure 44) generated to document structural features.

The slight angle of planking at the keep indicated low deadrise consistent with crabbing skiffs common to the Chesapeake Bay region during the late 19th and into the mid-20th centuries. M. V. Brewington documented a crabbing skiff with similar elements during his 1937 survey of fishing craft around the Chesapeake Bay (Figures 41 and 42).



*Figure 40.
Feature 9, an
unidentified
flat-bottomed
skiff.*



*Figure 41.
Crabbing skiff
documented by
M. V. Brewington in 1937.
(Courtesy of the Mariners'
Museum)*



Figure 42.
Inset of photo taken by
M. V. Brewington of a
crabbing skiff interior
during a 1937 survey
of Chesapeake Bay
craft. Note the cross-
planked interior, similar
to planking recorded in
Feature 10.



Feature 11: Bugeye (Hobbs Wreck)

Feature 11 is a primary contributing element to site 44SK0631. The feature consists of articulated remains of a Chesapeake Bay bugeye (Figure 45). Documentation of this craft took place from extant structure. Light washing of overburden mud from the hull exposed manufactured surfaces for recording. This type of craft was common to the region between 1870 and 1930 (Brewington 1963). Older examples are known, and a few examples survive but the height of their use is represented during that period. The hull style emerged to support the oyster fishery in the Chesapeake Bay and early examples of bugeyes include log bottoms. When large pine trees suitable for log-bottomed boats dwindled, plank and frame bugeyes replaced the log boats. Brewington (1963:44) states that log-bottomed bugeyes phased out around 1895.

Figure 43.
Feature 10, a wooden crabbing skiff hull.
Note the scarf joint in the keelson.

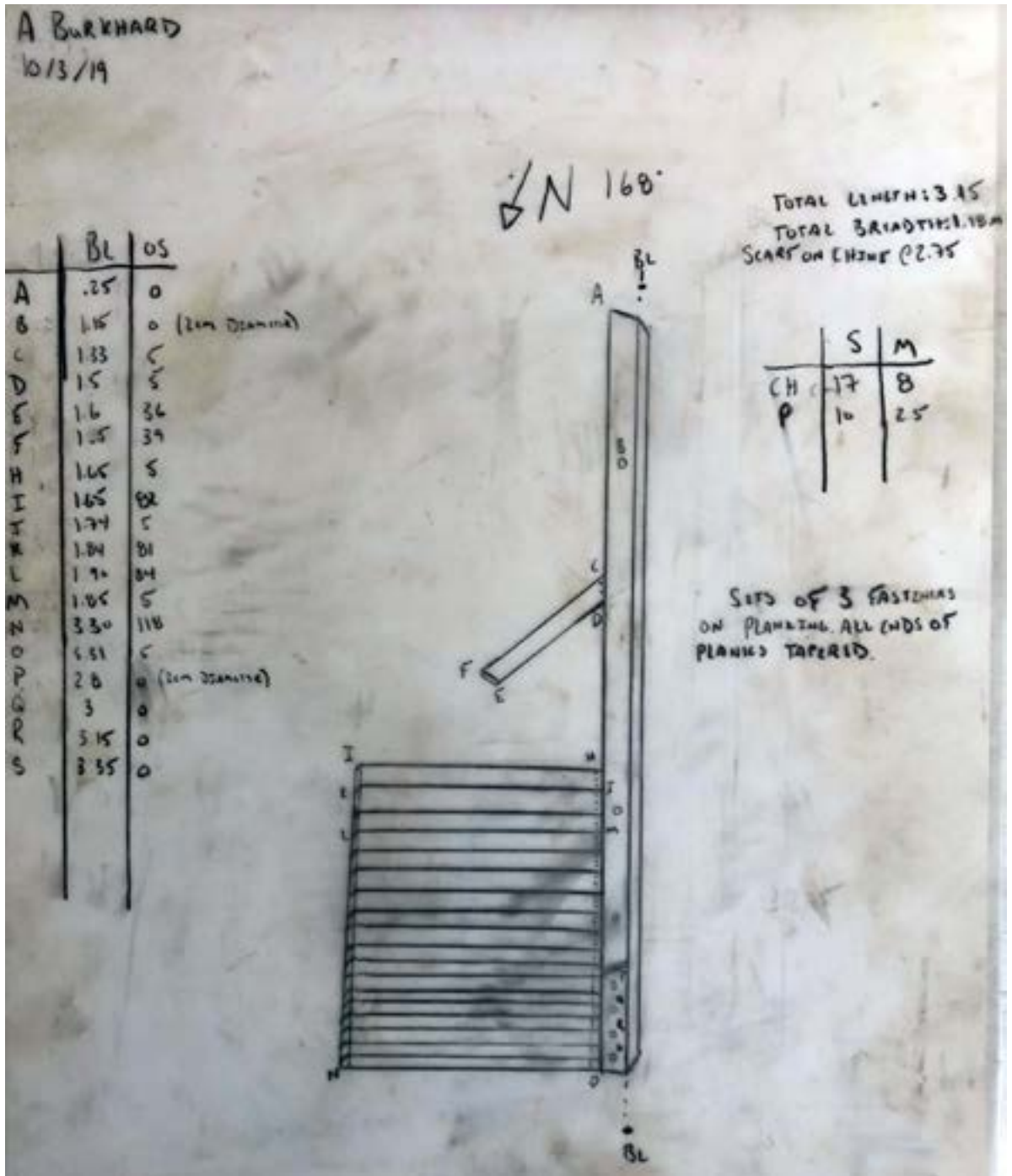

Figure 44.
Field drawing and
table of offsets
from Feature 10.

The bug-eye hull is characteristically double-ended and shallow. A few round or square stern bug-eyes were constructed but were anomalous. On the double-ended bug-eyes a patent deck overhung the stern to provide more deck area for the helmsman. Most bug-eyes were rigged with 'leg-o-mutton' sails, also known as bug-eye-rigged. Foremasts were typically taller than mainmasts, giving the appearance of a ketch rig. A very few bug-eyes were rigged with gaff, schooner sails where both masts were of equal height or the mainmast was slightly taller than the

foremast. These boats were known as being 'square-headed'. While the origin of the name is unknown, Brewington (1963:35) argues that this style of dedicated oyster-fishing boat followed 19th-century trends in focused labor division among Chesapeake communities.

Hull remains at Feature 11 are 14.18-m long by 5.33-m wide. Two mast steps are apparent along the upper face of the keelson. The mainmast step is placed slightly to port of the centerline and just ahead of the aftermost portion of the centerboard trunk. A cheek piece, to port of the

keelson, carries half of the upper portion of the mast step. The foremast step is cut into the centerline of the keelson but strengthened with two cheek pieces on either side of the step to fortify the keelson. A centerboard trunk, or "well," is located to starboard of the keel assembly and starts and ends with upright posts. A well log is fastened to the outer extent of the centerboard trunk and acts to carry half frames that terminate at the trunk. The bow section contains rising wood, perhaps a rocker block, to carry the stem upwards but only the lowest portion of the stem is present and mostly buried. At the stern, deadwood was present and carried the lowermost portion of the sternpost (Figure 48).

Several ceiling timbers remain that consisted of one-inch thick lumber in varying widths. Much of the ceiling has come loose, exposing the vessel's framing. Frame members appeared to be of a hard wood and were composite in nature. The master couple, frame station #18, was located at the after end of the centerboard trunk, slightly aft of the amidships line on the vessel. Framing convention reversed at the master couple, a traditional method of build to equalize

patterns in framing throughout the vessel. According to Pete Lesher (2019, elec. comm.), Curator at the Chesapeake Bay Maritime Museum, this bugeye was rigged as a gaff schooner. The forward placement of the mainmast step was unique to square-headed bugeyes (Figure 46). Out of more than 600 bugeyes constructed between the 1870-1918 only 37 were built as square rigged (Snediker and Jensen 1992:194). Among those, a number are accounted for as wrecked or demolished. Additional documentary work searching vessel registries and documentation of merchant vessels may indicate the identity of this wreck. Among McAnge's list of vessels, this vessel is larger than any of the listed schooners but was undoubtedly engaged in the oyster business in Suffolk.

General arrangement of the site, longitudinal, and transverse views of the site were recorded from laser collected data (Figure 50, Figure 50, and Figure 51). These drawings represent a non-traditional method of gathering sectional data and permit rapid collection of curves, lines, and features that otherwise would take much longer to accurately collect.

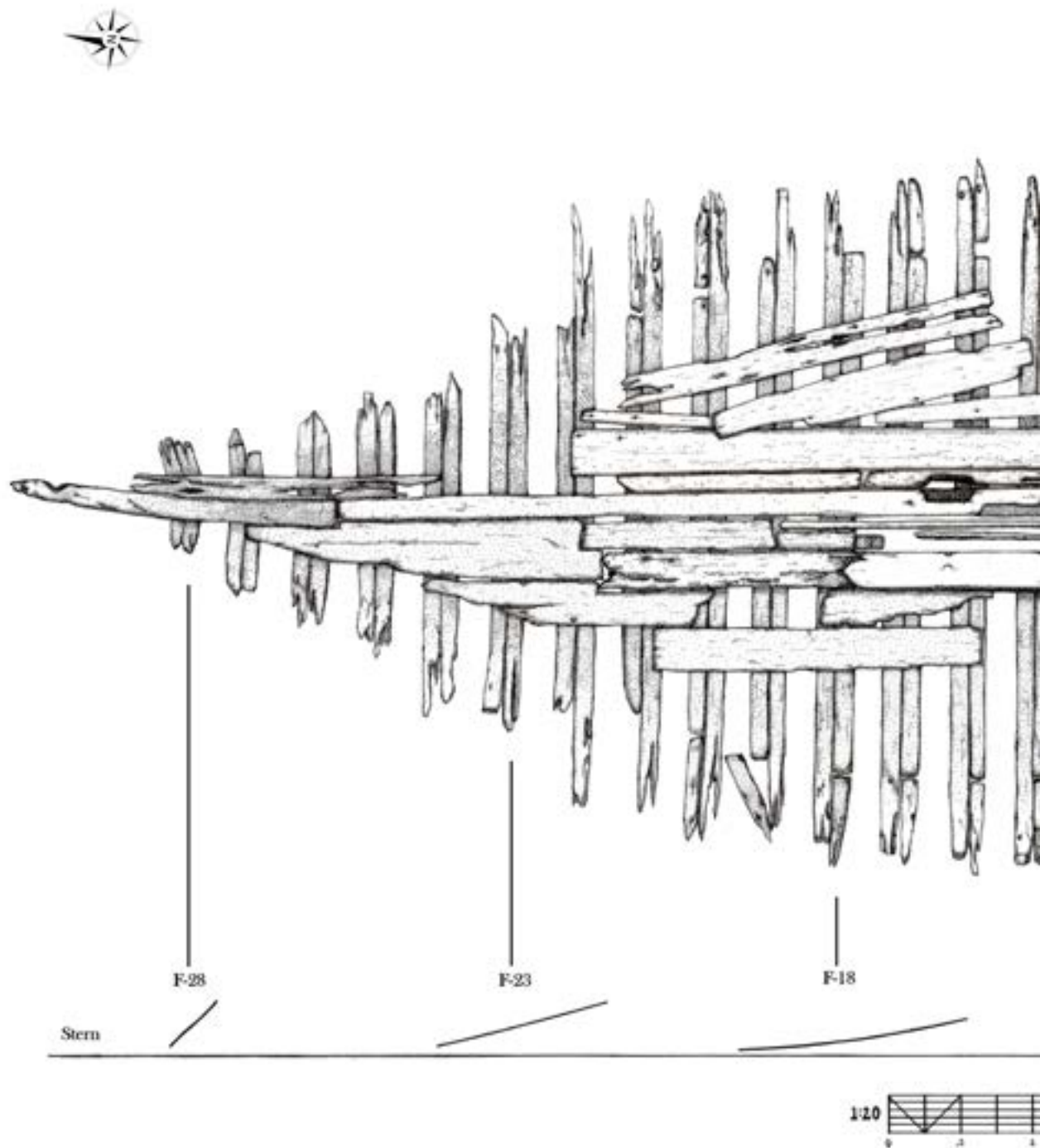

Figure 45. Feature 11, the Hobbs Wreck. Timber plan recorded during October 2019 field expedition. North is to the left. Vessel curves for extant remains are depicted at frame stations.

Hobbs Wreck

Nansemond Ghost Fleet Suffolk, VA

Feature 11

Drawing by Nicholas C. Badberg

May 5th, 2020

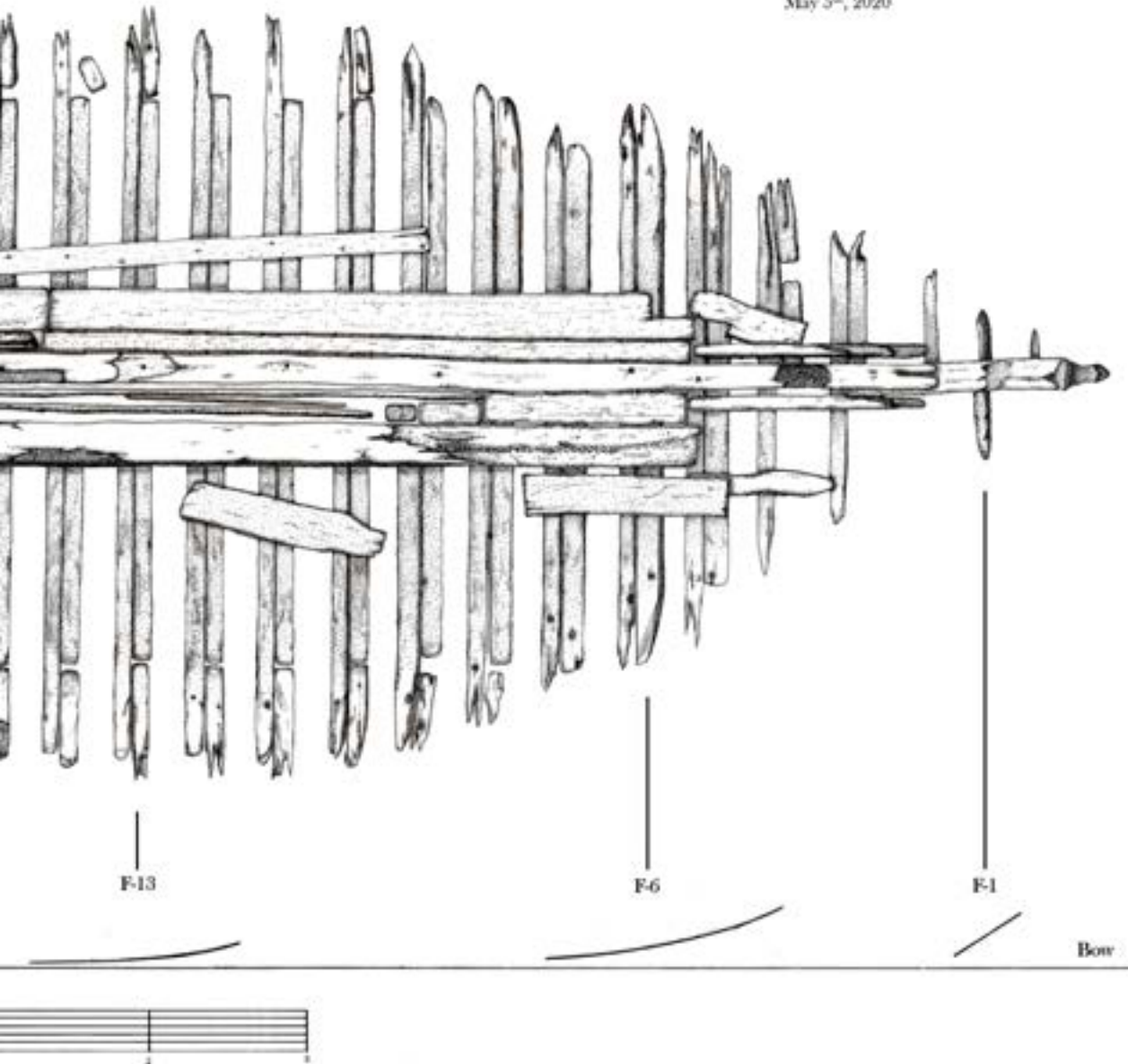



Figure 46. Inset of photograph taken by George Barrie in 1904 showing a square-rigged bugeye. Note the gaff-rigged sails and double-ended hull. This was one of only 37 known square-rigged bugeyes to be constructed. (Courtesy, Mariners' Museum)



Figure 47. The Hobbs Wreck, Feature 11, shown in orthoimagery. The bow is oriented to the right in this photo and north is to the left. Note the mainmast step, located ahead of the aftermost extent of the centerboard trunk. This feature indicates a schooner, or square-rigged, bugeye.



Figure 48. Feature 11, the Hobbs Wreck, looking from stern to bow. Note deadwood facing the camera, the sternpost fell away from the wreck sometime between February 13, 2020 and March 10, 2020. Note the flat nature of the lower hull, a feature common to bugeyes. While some additional flattening has occurred during the site formation process, this feature allowed bugeyes to transit shoal waters and access ports /docks in shallow creeks throughout the Chesapeake Bay region. The Constance Road Walgreens is seen in the background. View is to the south.

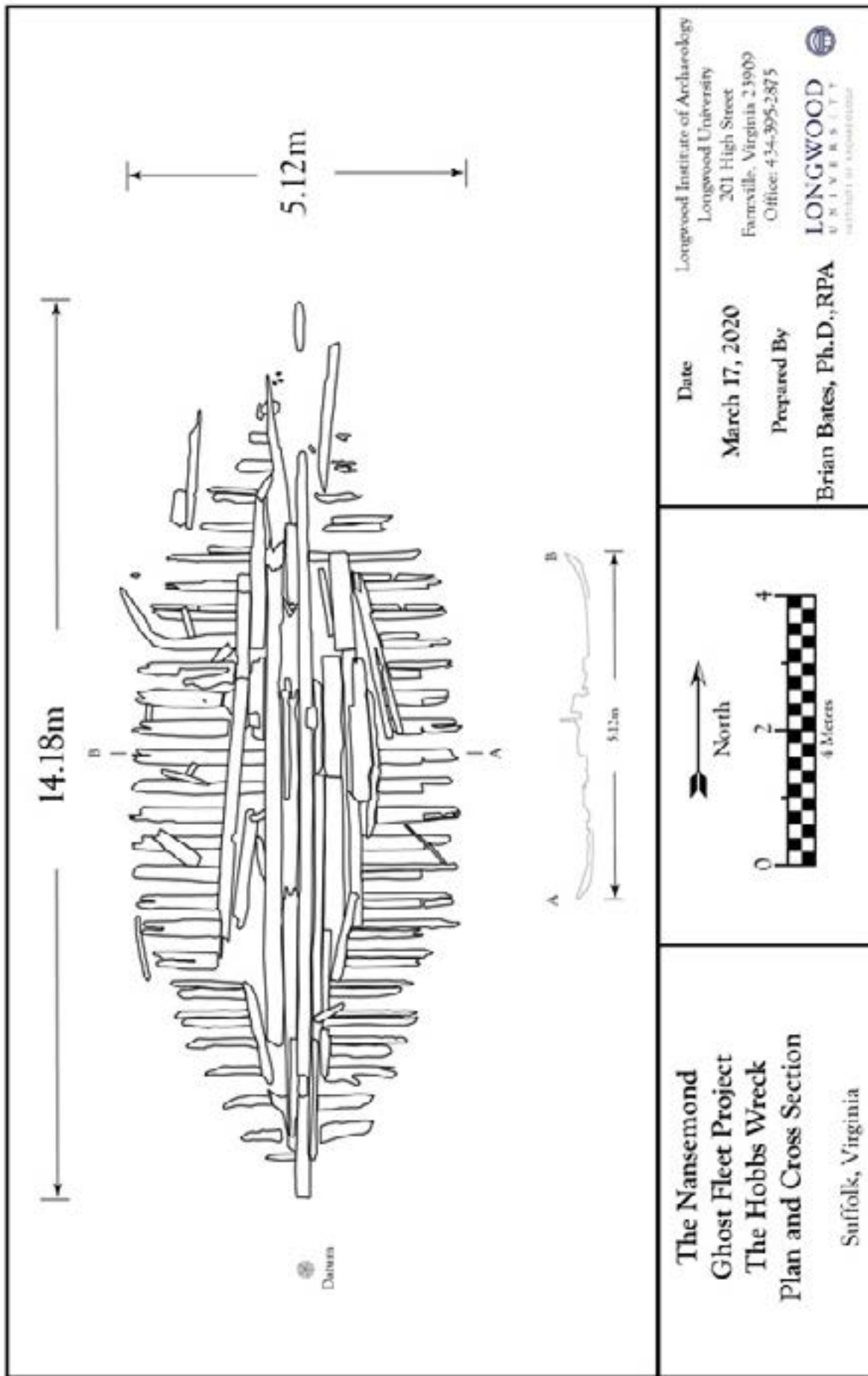

Figure 49. Plan drawing of Feature 11, the Hobbs Wreck.

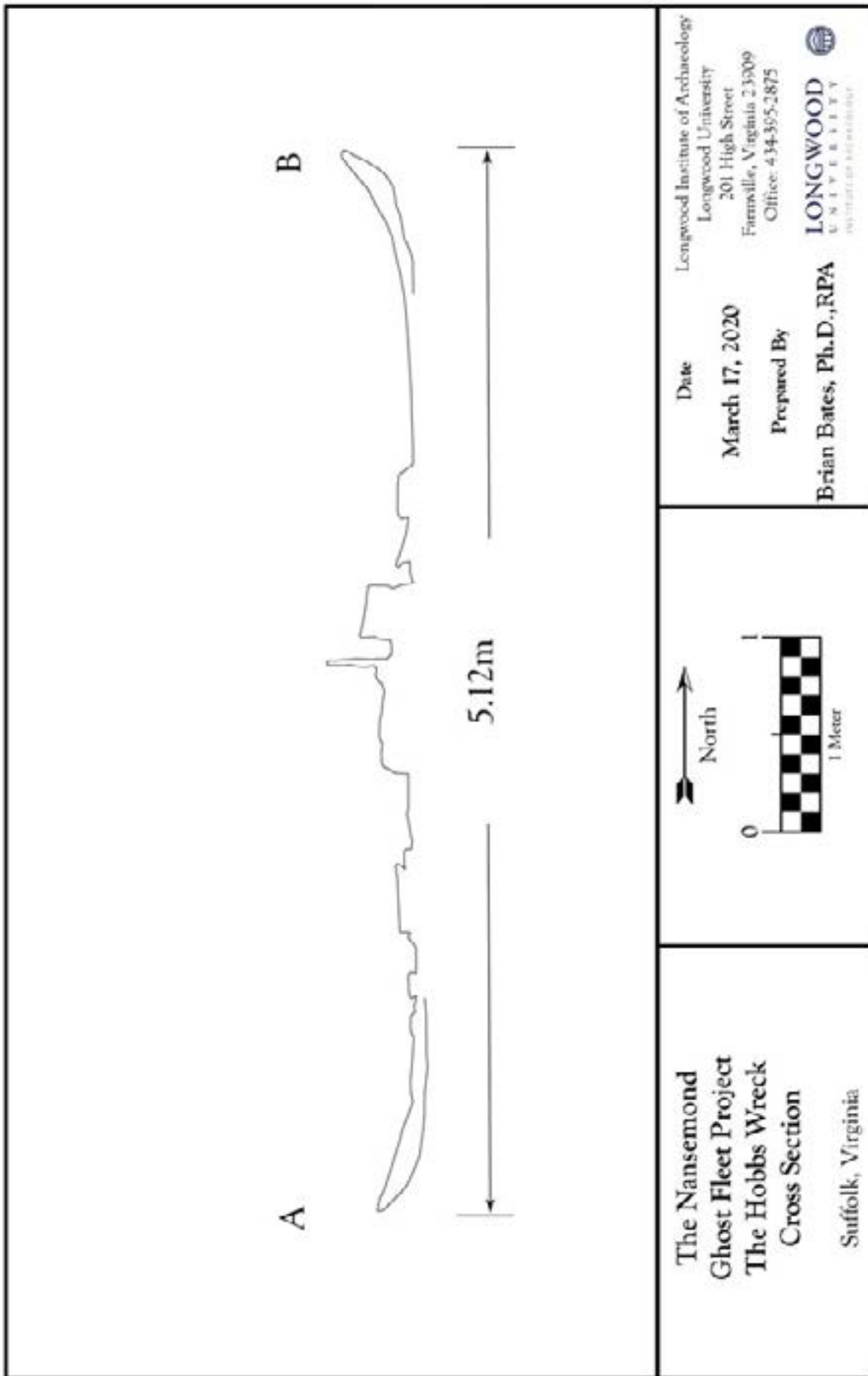

Figure 50. Feature 11 cross section view at centerboard trunk.

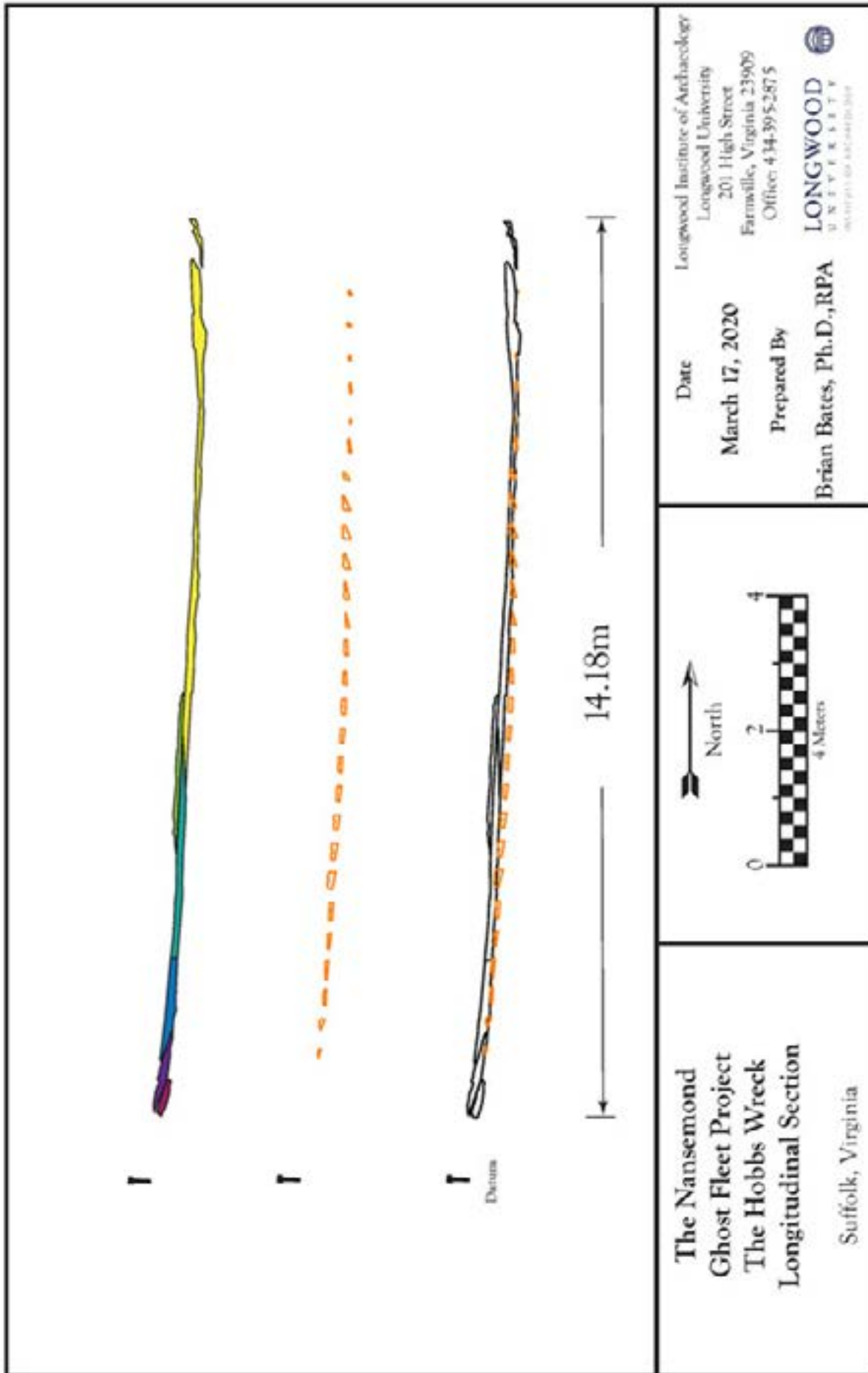

Figure 51. Hobbs Site in longitudinal section. The top image colors each timber independently.



Figure 52. Feature 41, pilings associated with the McAnge Oyster Company wharf and processing facility. Note Feature 10, the Hobbs Site, in the left-hand background.

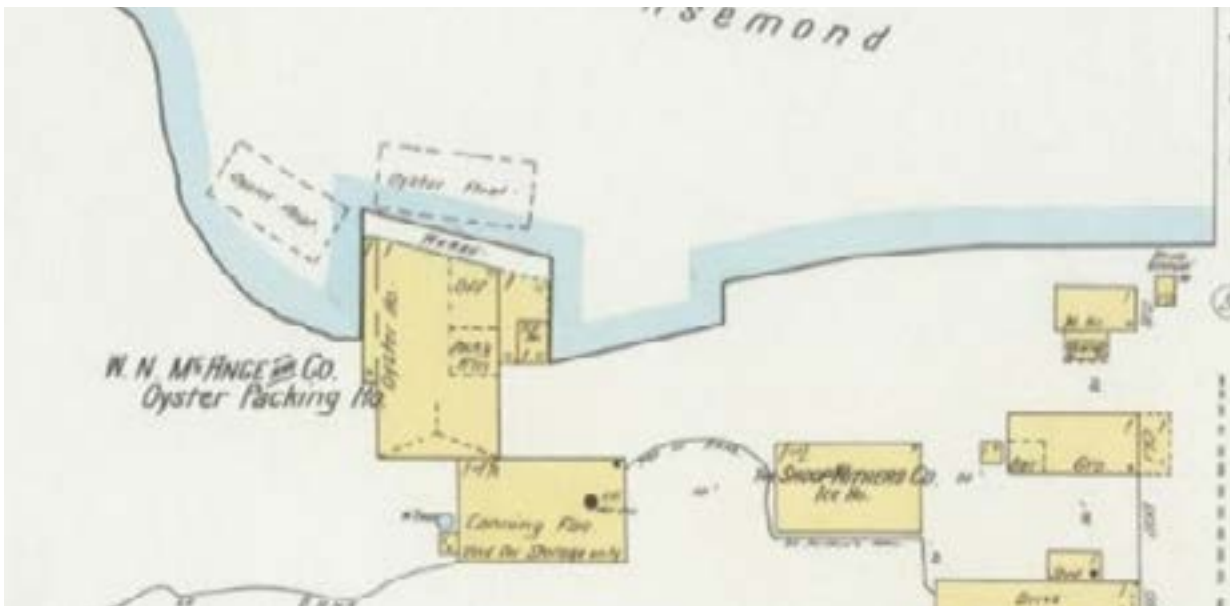

Figure 53. Sanborn Fire Insurance Map of 1898 showing the McAnge Oyster Company wharf and processing facility. (Courtesy, Suffolk Nansemond Historical Society)

Feature 12: McAnge Oyster House Wharf

Adjacent and to the east of Feature 11, the Hobbs Wreck, is a series of pilings (Figure 52). From arrangement and positioning of the pilings, it is likely that the feature represents foundational structure of the McAnge oyster house of 1880-1904. Sanborn Fire Insurance Maps indicate a structure in the area with an angled face to front the river channel. By 1898, oyster floats occupied the river adjacent to the oyster house on the north and west (Figure 53). It is likely that after abandonment of the oyster house sometime around 1904 that the wharf remains became a convenient place to

moor unused vessels, hence the deposition of the Features 8, 9, 10, and 11 boats. Proximity and positioning of the Feature 11 boat, the Hobbs Wreck, indicates that the vessel may have been moored to the building when it sank.

An attempt was made to map the pilings and other foreshore features during the October field phase but was thwarted by a lack of low water and a malfunctioning total station. Further work to document this resource is recommended.

Figure 54. Powerboat on south bank west of the Main Street Bridge. Note the inline six-cylinder gasoline engine.



Feature 13: Wooden Power Boat

Feature 13 represents a small powered pleasure craft abandoned on the riverbank approximately 46 meters west of the Main Street Bridge (Figure 54). The vessel was identified on March 10, 2020 during a period of unusually high water. Since field crew were not visiting the site with the intent of capturing data, they made no measurements of the vessel. Observations of the vessel include a diagonally planked wooden hull, powered with an inline six-cylinder gasoline engine (Figure 55). The stern of the vessel was still submerged but the hull is estimated to be in excess of seven meters.

Diagonal planking, similar to cold molding, allowed boatbuilders to form a curving hull from diagonally laid, flexible, thin strips of wood. Canvas was often used between layers and treated with a waterproofing preservative to make the hull watertight. The thin nature of the strakes allows for compound curves to be formed without needing to splice planking. Less wood is wasted but diagonally planking small vessels necessitates a large amount of liquid adhesive, traditionally a formaldehyde-based glue or in modern times, epoxy resins. Cold molding using thin strakes and glue is a boatbuilding technique that was adapted from the aeronautical industry during World War II. The technique formed an exceptionally strong and lightweight hull, and it became a popular method of building pleasure craft prior to the advent of fiberglass hulls during the 1960s. Therefore, the Feature 13 boat likely dates to 1945-1970 and served as a speedboat on the Nansemond. Local informants in Suffolk mentioned the area above the Main Street Bridge



Figure 55. Detail of the Feature 13 boat. Note two layers of diagonally-laid planks and copper-alloy screws at frame stations. A frame is seen in the middle left-hand side of the picture and the engine is in the background.

being a popular place for waterskiing. Considering the relatively large engine for the vessel's size, operators likely used this type of boat to pull people on water skis.

This feature was only observed on March 10, 2020. Further examination and documentation is recommended.



*Figure 56.
Cribbing west of the Main Street Bridge
exposed during an unusually low tide in March
2020.*

Feature 14: Cribbing

Immediately west of the Main Street Bridge on the south bank of the river is an area of heavy cribbing installed as shoring for the bankline. Pilings and trash masked this feature during the sonar survey, leaving it unidentified in the acoustic record. However, the unusually low tide on March 10, 2020 exposed the riverbank much lower than witnessed before.

The cribbing consists of heavy, squared timbers overlapped to form a three-sided rectangular structure parallel to the bank. Corners of the timbers are square-notched on the bottom sides to overlap the lower log. This cabin-style notching prevents internal pressure from forcing the corners apart.

Fill inside the cribbing varied from sand, brick

rubble, and rounded cobbles. Farther out into the river, round pilings supported an overhanging structure such as a wharf or oyster house.

The Singleton family occupied the area during the 1860s (Figure 56), and continued their ownership when operating a warehouse on the property in 1889, as documented by the Sanborn Fire Insurance Company (SNHS) (Figure 57). By 1921, an oyster house occupied the location of Feature 14 (Figure 58). The cribbing and pilings may represent the construction sequence of that oyster house. Further examination of this feature should include sample of sediments and fill materials to seriate the occupation sequences in relation to architectural features.



Figure 56a.
Feature 14 is located approximately where the picket fence and small buildings to the right are drawn on this Harper's Weekly depiction of downtown Suffolk in March of 1863. (Courtesy, Suffolk Nansemond Historical Society)

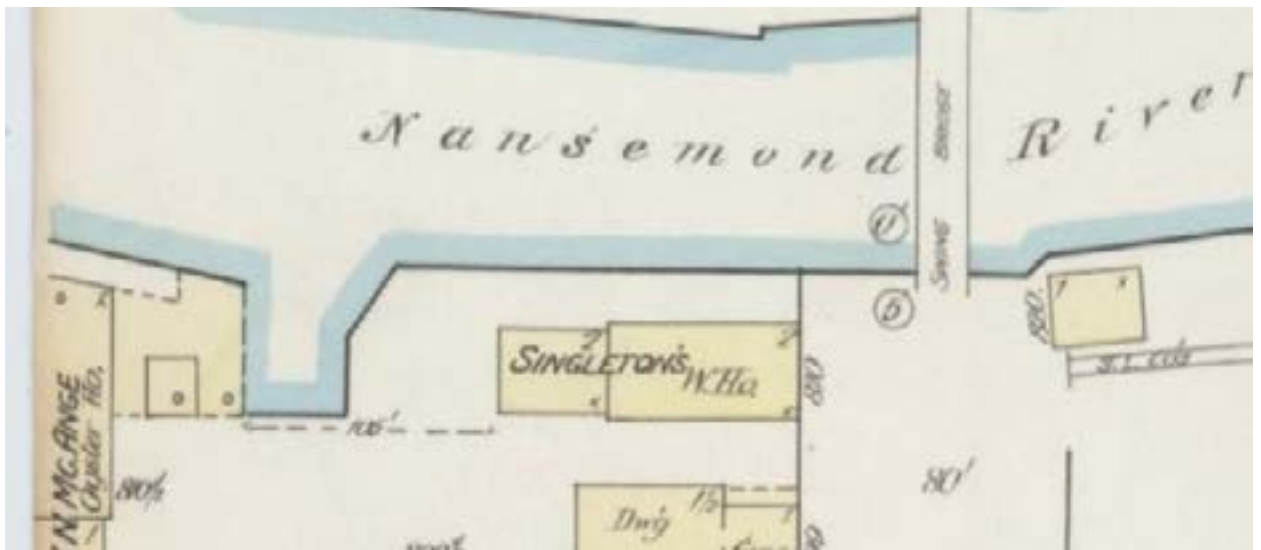

Figure 57.
1888 Sanborn Fire Insurance Map showing the area of Feature 14. Log cribbing is located along the riverbank in the vicinity of Singleton's warehouse. (Library of Congress)

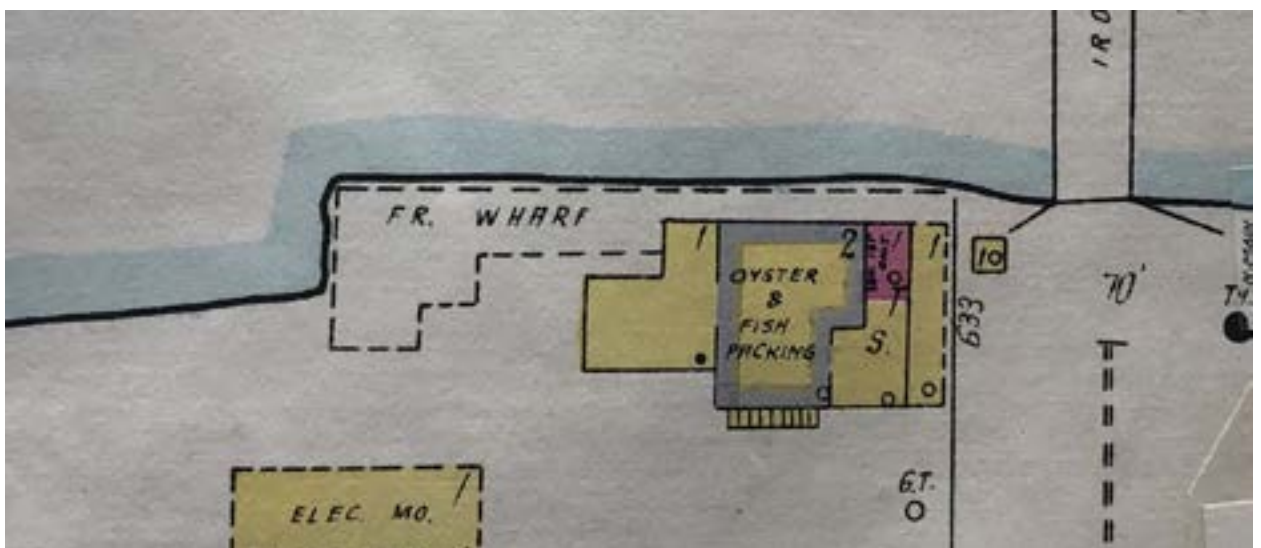

Figure 58.
Area of Feature 14, depicted on a 1921 Sanborn Fire Insurance Company Map. Cribbing and pilings associated with Feature 14 possibly relate to the construction of this building and wharf.



Figure 59. Feature 15 is seen in the right-hand portion of this aerial photo taken on October 14, 2019. A line of pilings can be seen wrapping the point of land immediately west of the Main Street Bridge. Feature 6, the Funkhouser Fleet, appears in the left-hand side of the photo. (Courtesy, Fairfield Foundation)

Feature 15: North Bank Pilings

At the inside of the elbow in the Nansemond River, immediately upstream of the Main Street Bridge is a line of wooden pilings (Figure 59). Measuring approximately 46 meters in length, the continual line of pilings consists of two angles that comprise three faces of nearly-equal lengths. Some of the easternmost pilings have

horizontal fender boards still in place and the middle face of pilings is doubled. This area was examined from canoe on September 30 and October 1, 2019. Additional field examination and documentary work is recommended on this feature.

DIGITAL RECORDATION OF SITE 44SK0631

Fieldwork to digitally record features of Site 44SK0631 was undertaken February 11-13, 2020 and consisted of the following activities:

1. High-definition survey using a Leica C-10 Scan Station.
2. Recordation of locational information for the observed shipwrecks using a Trimble Geo 7 sub-decimeter global positioning system (GPS).

The field data collection was accomplished for two areas, the Hobbs Wreck (Feature 11) and the Funkhouser Fleet (Feature 5). For each area a series of 6-inch diameter survey targets were set up in order to establish survey control. The Trimble GPS recorded the location for each target. High-definition surveying was accomplished using a Leica Geosystems C10 Scan Station. The Leica C10 is a LiDAR device capable of collecting 55,000 highly accurate three-dimensional points per second out to a range of 300 meters with an accuracy of +/- 2mm. Data collected at each scan station creates a point cloud comprised of the three-dimensional points known as a scan world.

Data collection commenced at the Funkhouser Fleet (Feature 5) first through a series of scanner set-ups, known as scan stations. The data was collected at either side of low tide which was approximately 06:46 hours on the date of the survey. A total of four survey scan stations were established over a period of about three hours before the incoming tide made any further data collection impossible. This was sufficient time to allow for collection of all of the observable wrecks at what was forecast to be the lowest tide sequence of the year. At the lowest tide, the perimeter of two of the Funkhouser wrecks were plotted using the Trimble GPS.

The Hobbs wreck was surveyed at either side of the next low tide at approximately 19:13 hours. Three survey scan stations were established over a period of approximately two hours and allowed for sufficient data collection for this small wreck site. At the lowest tide, the perimeter of the Hobbs Wreck was plotted using the Trimble GPS. This concluded the field data collection phase of the project.

Post-Field Data Processing and Project Deliverables

The field data collection resulted in several kinds of information that required post-processing and analysis at the Institute of Archaeology at Longwood University. The Leica C-10 Scan Station point cloud data was post-processed using Leica Cyclone 9.4.2 software. The first step in the process involved loading all scan worlds from each of the survey areas into the software and then combining them into what is known as a registration. During this process, alignment of the individual point clouds into one unified point cloud registration was achieved through various automatic and manual manipulations of the data to get them into alignment with one another.

Cyclone is capable of calculating the amount of error in any given registration with the maximum acceptable registration error being 0.011'. For the Funkhouser Fleet scan world the registration error was 0.007' and for the Hobbs Wreck it was 0.000'. Once registered, the point cloud data was ready for further analysis. The Hobbs Wreck was edited (clipped) to remove much of the scan world not related to the actual wreck and both the edited and unedited versions were archived, while the Funkhouser Fleet point cloud was not clipped. The resulting point clouds are Deliverable 1 for this project.

The registered scanworlds were exported from Cyclone into the Leica TruView software so that the scans could be viewed through the Longwood Institute of Archaeology's secure TruView portal for one year, representing Deliverable 2 for this project.

The data from the Trimble GPS was post-field processed using Trimble Pathfinder Office 5.85. The raw field data was differentially corrected using data available from reference stations. The post-processed GPS accuracy for all locations collected was determined to be 0.1 meter. The post-processed GPS data was used to create maps and shape files for the project using ESRI ArcGIS 10.5. The shape files resulting from this process are Deliverable 3 for this project.

Deliverable 4 was intended to be a fly-through of the point cloud data generated using Cy-

clone. While not a great resource from a preservation perspective, this deliverable was seen as a good public relations output for the project. Producing this fly-through relies upon the imagery data — separate from the point cloud — that the project team collected using an iStar panoramic camera. The resulting imagery is then used to color the point cloud with actual imagery from the project area. The software could not accurately achieve this to the standard necessary for fly-through production. The reason for this was that the software could not account for the lowering and rising tide that was constantly moving during data collection. Deliverable 4, as envisioned, was not possible.

In order to offset for not being able to produce the fly-through, the data from Cyclone was exported using Leica Jet Stream software to facilitate working with the point cloud data in AutoCAD Civil 3-D. In AutoCAD, measured drawings of the Hobbs Wreck were prepared that show the plan view, longitudinal section view, and cross section or transverse section view of the wreck. These measured drawings have an accuracy of +/- 2mm and are much more useful, from a preservation perspective, than the fly-through would have been. The measured drawings of the Hobbs Wreck are a substitute for Deliverable 4.

SUMMARY AND RECOMMENDATIONS

Survey of historic materials within, and adjacent to, the Nansemond River near downtown Suffolk, Virginia revealed a late 19th century and early 20th century concentration of abandoned vessels, cribbing, architectural remains, and a broad artifact scatter. Efforts to delineate these resources resulted in site 44SK0631. The site contains fifteen distinct cultural features, many of which are complex structures or collections of abandoned historic vessels worthy of further research. Field documentation sought to provide basic identification for each of the features contributing to the resource group. Documentary research and community outreach provided insight into the maritime landscape of Suffolk, particularly during the 1860-1940 period.

Most waterfront municipalities developed disposal areas for urban waste and industrial byproduct, including abandonment areas for watercraft. Such deposits speak to the history and development of local and regional economies, and tie into broader global forces that direct the flow of goods, ideas, architecture, and culture (Richards 2002). In many cases these resources have been built-over, dredged-away for harbor improvements, or removed as unsightly environmental hazards. In the case of Suffolk, the Nansemond Ghost Fleet Site (44SF0632) provides a glimpse into one of the city's most pivotal chapters. Rebounding from economic desertification wrought by the Civil War, Suffolk leaned on its maritime commerce as much as its railroads to get back onto firm footing. The oyster, shingle, lumber, brick, and lime businesses that fronted the Nanse-

mond were a crucial part of Suffolk's economic engine. The Nansemond Ghost Fleet contains elements of each of these industries. Additionally, the diversity of vessel types present within the site is unique and highly valuable to the understanding of watercraft development, morphology, and use throughout the Chesapeake Bay region.

The Nansemond Ghost Fleet has much to provide, and further work on the site is recommended to better identify and place historic watercraft and understand architectural remains on the riverbank. Additionally, the sheet midden of artifact contained along the southern bank deserves further attention. Natural decay and human interaction threaten each feature within site 44SK0631. Given the public nature of the resource, it serves as an example for the importance of public engagement with archaeological resources. During the field phase, Suffolk residents who learned about the site and its vessels approached researchers on multiple occasions to express their concern for, and appreciation of, the archaeological resource. In each case, interest was spurred by media attention surrounding this project or a component of public outreach such as presentations and speaking engagements. Public stewardship of sites like this, in addition to protections afforded archaeological sites by the Code of Virginia, is often an effective way to appreciate sites that will largely be lost to natural erosional factors. The Nansemond Ghost Fleet will inevitably continue to erode, rot, and otherwise decay. Continued research into the site, as well as additional survey and documentation is recommended.

WORKS CITED

- Brewington, M. V.
1963 *Chesapeake Bay Log Canoes and Bugeyes*. Cornell Maritime Press. Cambridge, Maryland.
- Burgess, Robert H.
1963 *This Was Chesapeake Bay*. Tidewater Publishers. Centreville, Maryland.
- Chowning, Larry S.
2007 *Deadrise and Cross Planked*. Tidewater Publishers. Centerville, Maryland.
- Dodds, Richard J. S. and Robert Hurry
2009 *Boats for Work, Boats for Pleasure: The Last Era of Wooden Boatbuilding in Southern Maryland*. Calvert Marine Museum. Solomons, Maryland.
- Evans, Clement A.
1899 *Confederate Military History*. Confederate Publishing Company. Atlanta, Georgia. Accessed online https://en.wikisource.org/wiki/Page:Confederate_Military_History_-_1899_-_Volume_3.djvu on May 8, 2019.
- Fleetwood, William C.
1995 *Tidecraft: The Boats of South Carolina, Georgia and Northeastern Florida, 1550-1950*. WBG Marine Press. Tybee Island, Georgia.
- Gallivan, Martin D., Thane Harpole, David A. Brown, Danielle Moretti-Langholtz, and E. Randolph Turner III.
2006 "The Werowocomoco (44GL32) Research Project: Background and 2003 Archaeological Field Season Results." College of William and Mary, Department of Anthropology. Research Report Series Number 1. Williamsburg, Virginia.
- Gleach, Frederic
1997 *Powhatan's World and Colonial Virginia: A Conflict of Cultures*. University of Nebraska Press. Lincoln, Nebraska.
- Gilmer, Thomas C.
1982 *Chesapeake Bay Sloops*. Chesapeake Bay Maritime Museum. St. Michaels, Maryland.
- Hobbs, Kermit and William A. Paquette
2006 *Suffolk; A Celebration of History*. Donning Publishers. Virginia Beach, Virginia.
- Hotchkiss, Jed
1899 *Confederate Military History*. Confederate Publishing Company, Atlanta, Georgia
- Kepner, Charles H.
1979 *The Edna E. Lockwood*. Chesapeake Bay Maritime Museum. St. Michaels, Maryland.
- Lutz, Lara, Martin D. Gallivan, E. Randolph Turner III, David A. Brown, Thane Harpole, Danielle Moretti-Langholtz
2015 *Virginia Indians at Werococomoco; A National Park Handbook*. Virginia Department of Historic Resources. Richmond, Virginia.
- Maxwell, William
1850 *The Virginia Historical Register and Literary Note Book*. Virginia Historical Society. MacFarlane & Ferguson, Richmond, Virginia. Accessed electronically on March 15, 2020. <https://books.google.com/books?id=zy-4dAAAAMAAJ&pg=PA117&lpg=PA117&dq>

-
- Neal, Peter R.
1959 "The History of the Nansemond River". Honors Thesis on file with the University of Richmond. Electronically accessed on May 5, 2019. <https://scholarship.richmond.edu/cgi/viewcontent.cgi?article=1617&context=honors-theses>
- Parker, Ruel B.
1993 *The Sharpie Book*. International Marine Press. Camden, Maine.
- Pollock, Edward
1886 *Sketch Book of Suffolk its People and its Trade*. Fiske & Purdie. Portsmouth, Virginia. Accessed electronically on December 2, 2019. <https://archive.org/details/sketchbookofsuff00poll/page/n5/mode/2up>
- Richards, Nathan
2002 *Deep Structures: An Examination of Deliberate Watercraft Abandonment in Australia*. Doctoral dissertation, Department of Archaeology, School of Humanities. Flinders University of South Australia.
- Rountree, Helen C.
1990 *Powhatan's People: The Powhatan Indians of Virginia Through Four Centuries*. University of Virginia Press. Charlottesville, Virginia.
- Rountree, Helen C.
2005 *Powhatan's Powhatan Opechancanough; Three Indian Lives Changed by Jamestown*. University of Virginia Press. Charlottesville, Virginia.
- Saunders, Bruce and Marion Joyner Watson
1998 "Nansemond County Civil War Veterans". Manuscript on file with the Suffolk Nansemond Historical Society. Suffolk, Virginia.
- Snediker, Quentin and Ann Jensen
1997 *Chesapeake Bay Schooners*. Tidewater Publishers. Centreville, Maryland.
- Vojtech, Pat
1993 *Chesapeake Bay Skipjacks*. Tidewater Publishers. Centreville, Maryland.
- Wagner, Marc Christian and Richard Laub
1986 "Suffolk, Virginia National Register of Historic Places Inventory – Nomination Form". National Preservation Institute, Washington D.C. Electronically accessed on March 12, 2020. https://www.dhr.virginia.gov/VLR_to_transfer/PDFNoms/133-0072_Suffolk_HD_1987_Final_Nomination.pdf
- Wennersten, John R.
1981 *The Oyster Wars of Chesapeake Bay*. Tidewater Publishers. Centreville, Maryland.
- White, Christopher
2009 *Skipjack. The Story of America's Last Sailing Oystermen*. St. Martin's Press, New York, New York.

APPENDIX 1. FEATURE 11, THE HOBBS WRECK, 3-D MODEL IMAGERY



Figure 1. Hobbs Wreck 3D model from above. North, and stern, is up.



Figure 2. Bow view of the Hobbs Wreck.

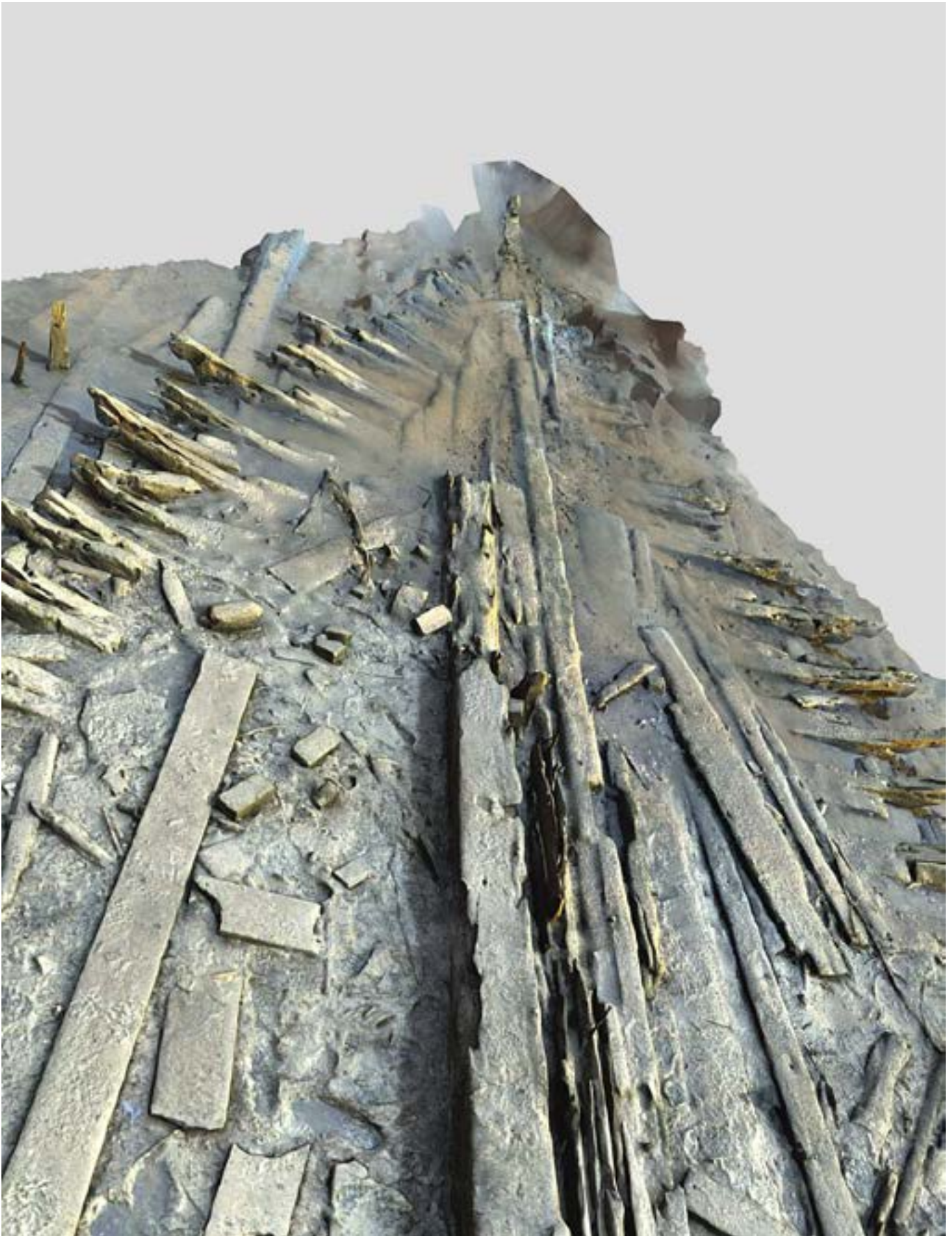

Figure 3. Stern view of the Hobbs Wreck.



Figure 4. Closeup view of the Hobbs Wreck mainmast step. Note the step is placed off center from the keelson and strengthened by a cheek piece.

**APPENDIX 2. LASER IMAGERY GATHERED FROM THE FUNKHOUSER FLEET
AND HOBBS WRECK**



44SK0631 Hobbs Site Vessel – Feature 11. Orthographic view of a historic bugeye from starboard quarter.



44SK0631 Hobbs Site Vessel – Feature 11. Orthographic view of a historic bugeye from port quarter.

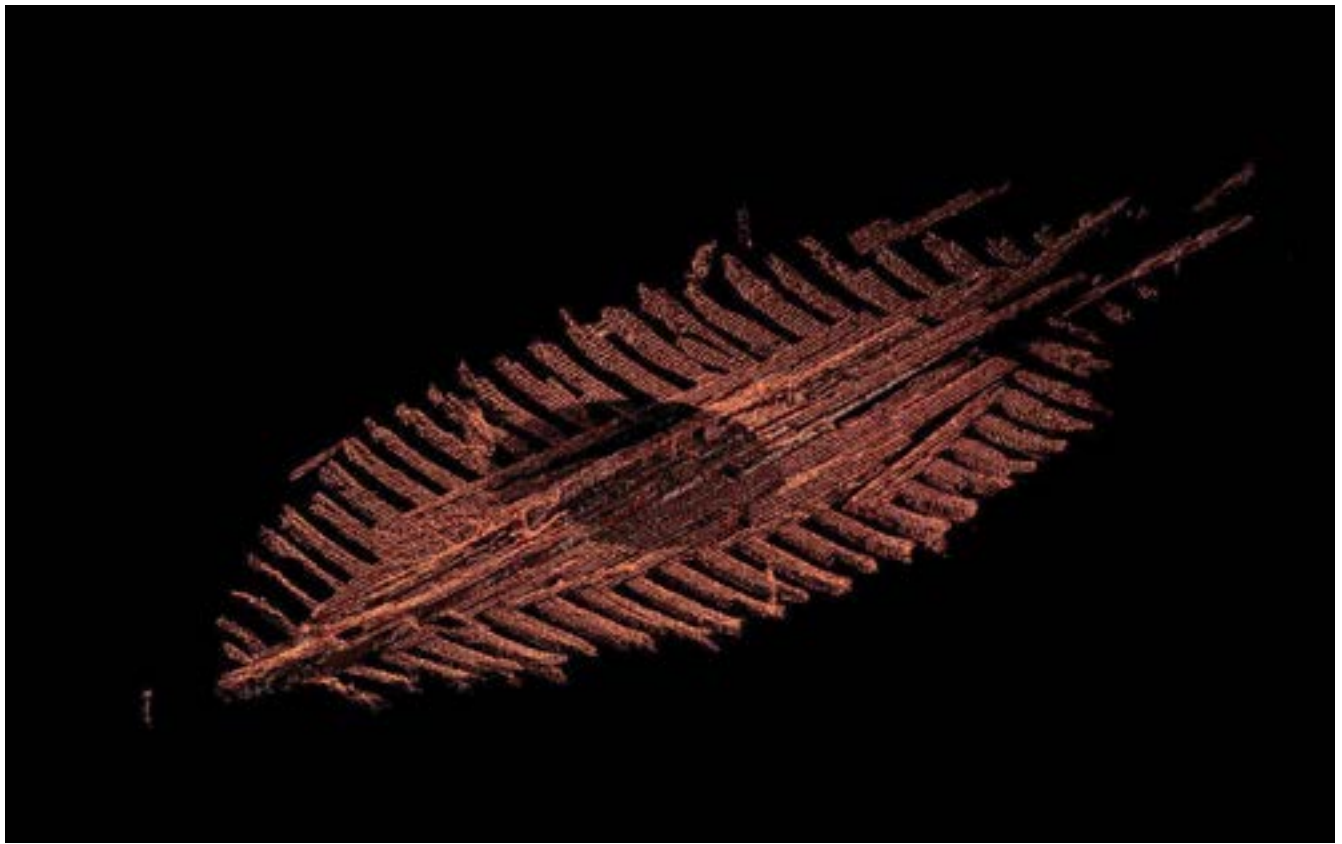

44SK0631 Hobbs Site Vessel – Feature 11. Orthographic view of a historic bugeye from the port bow.

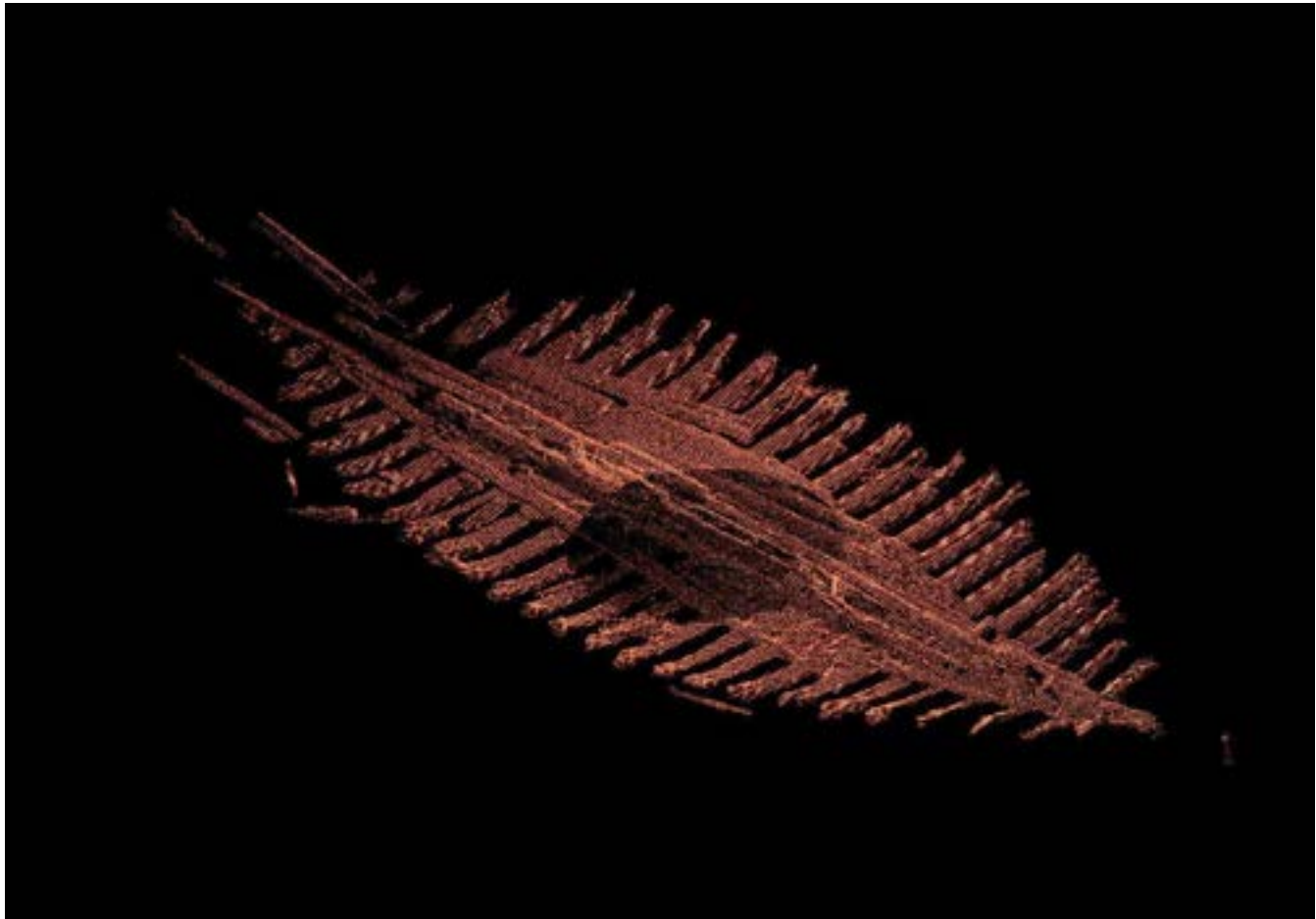

44SK0631 Hobbs Site Vessel – Feature 11. Orthographic view of a historic bugeye from the starboard bow.

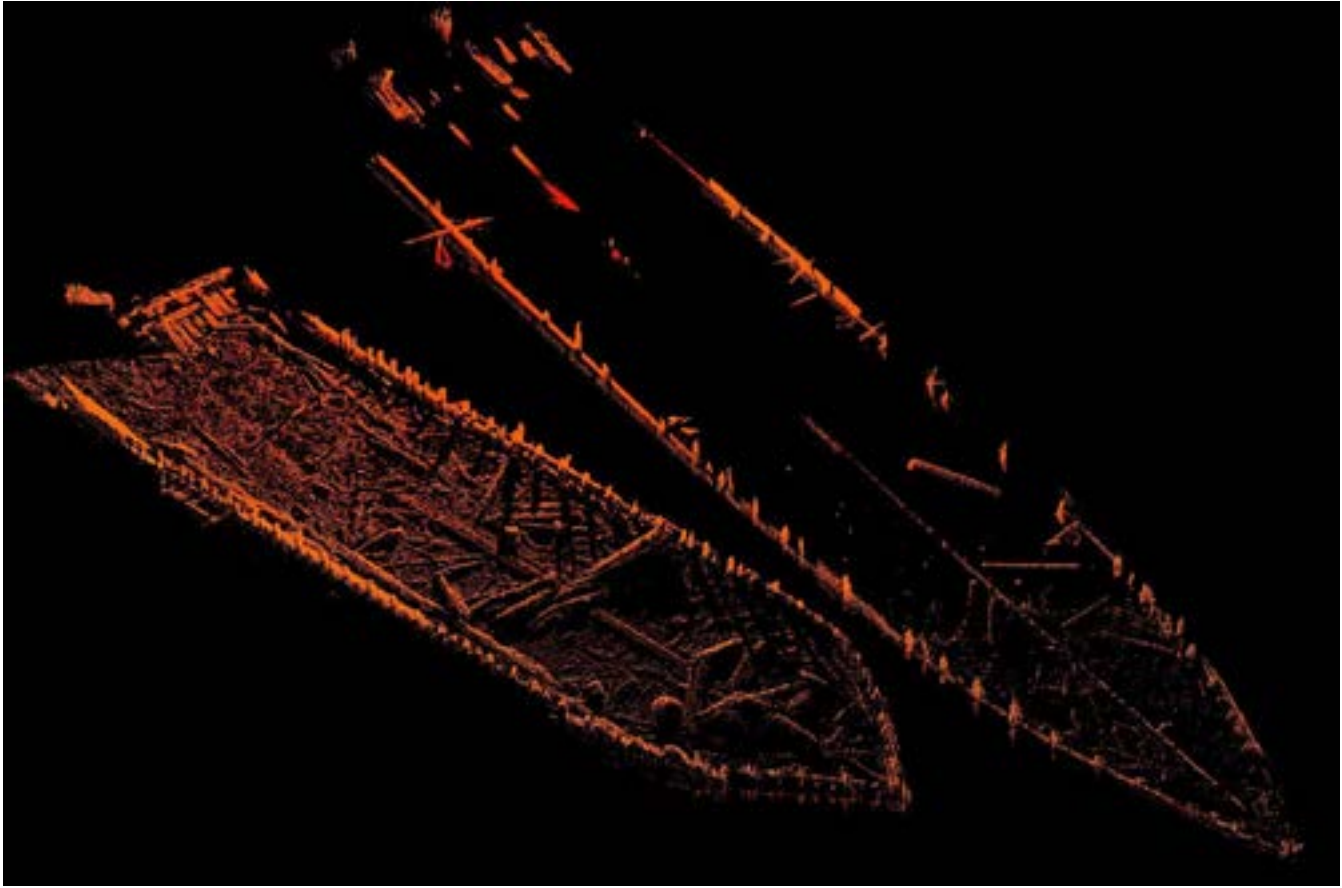

44SK0631 Funkhouser Fleet – Vessels 1 and 2 (L-R)

APPENDIX 3. SELECTED SIDE IMAGING SONAR VIEWS

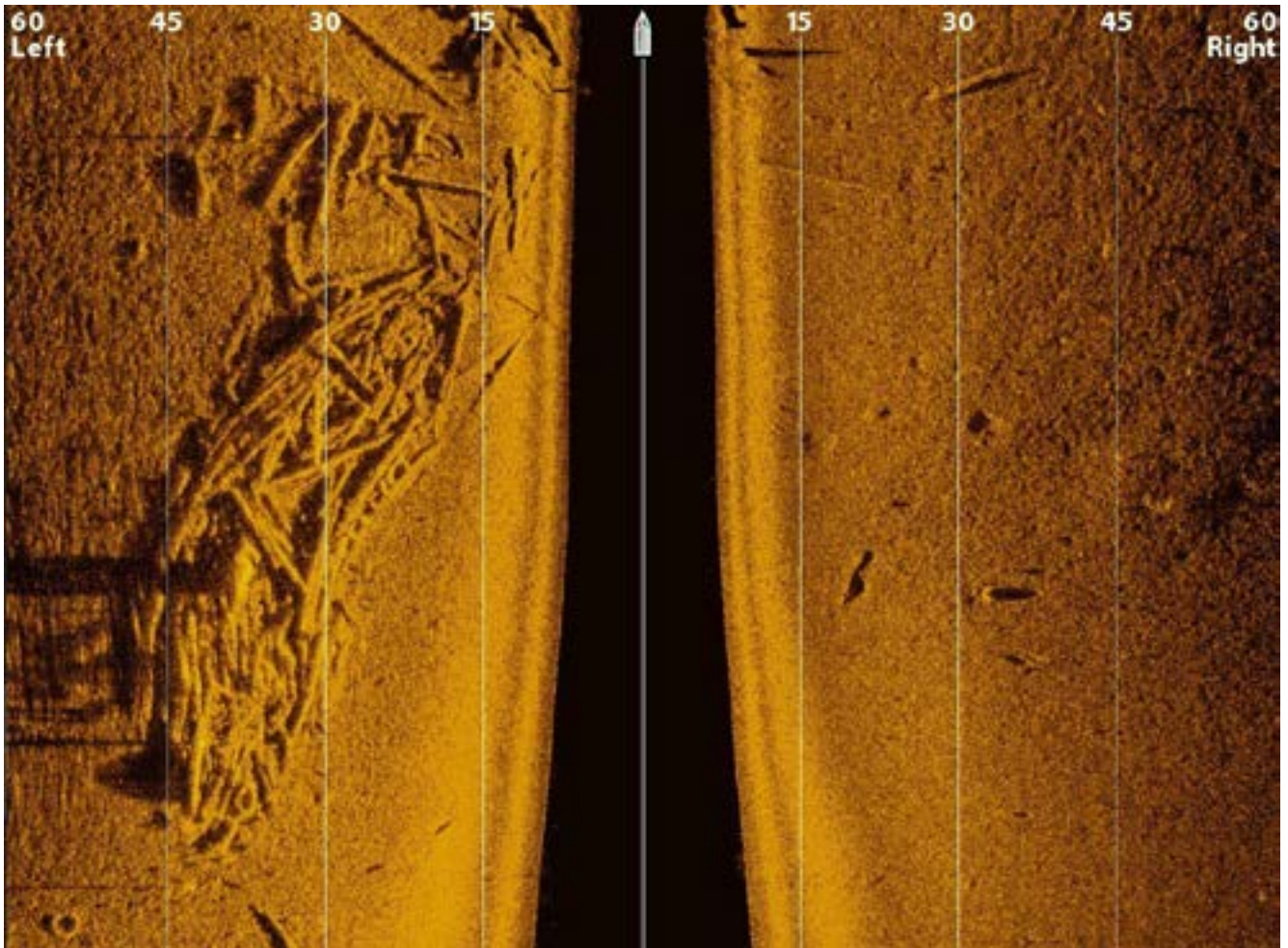

Figure 1. Vessel 6 of the Funkhouser Fleet seen on the port channel in this image. Note shallowing bathymetry from bottom to top.

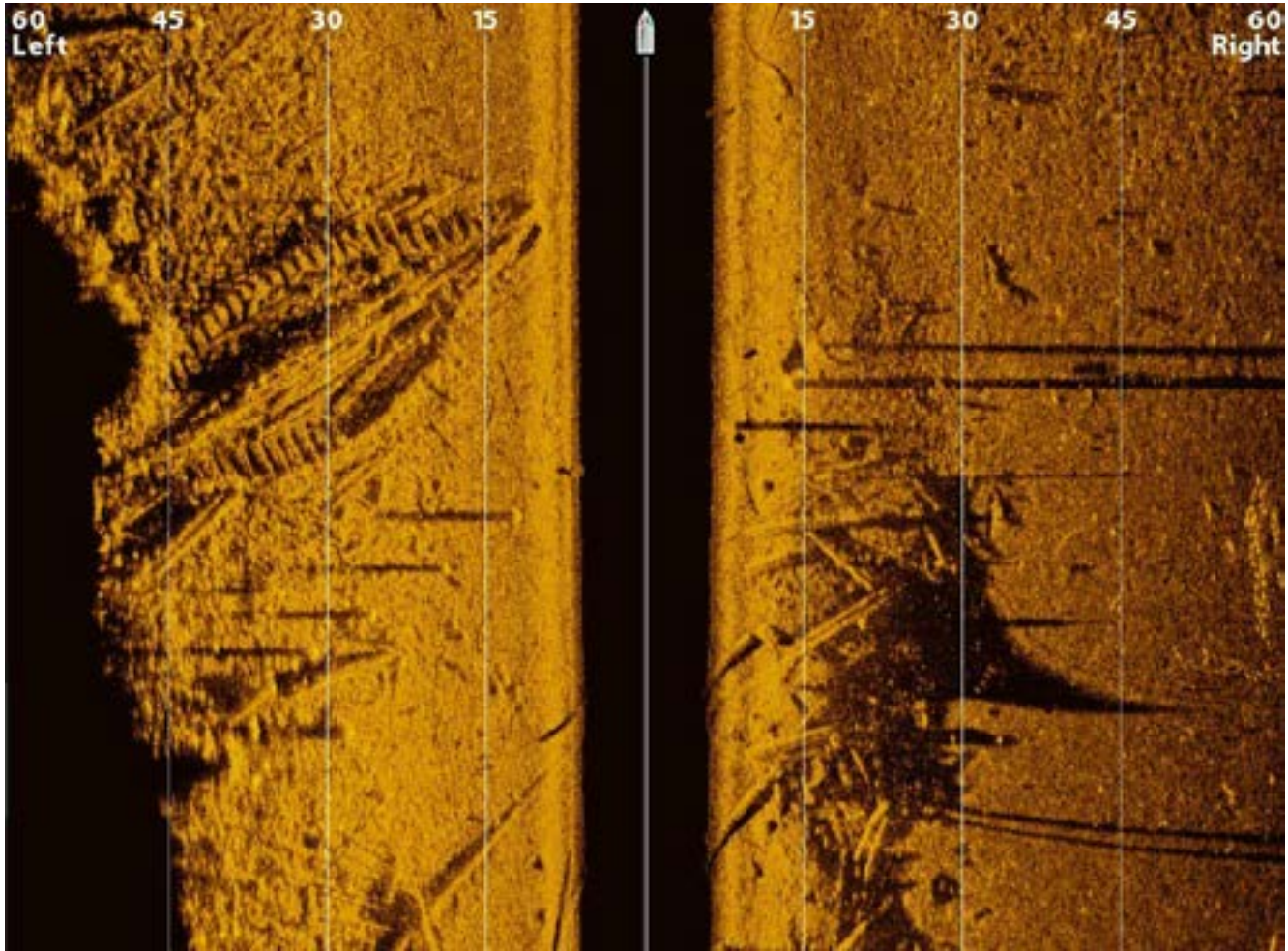

Figure 2. The Hobbs Wreck, Feature 11, seen on the port channel of this image. Note timbers and debris in the water in the lower right-hand side of the image, possibly remains of the original McAnge Oyster House.

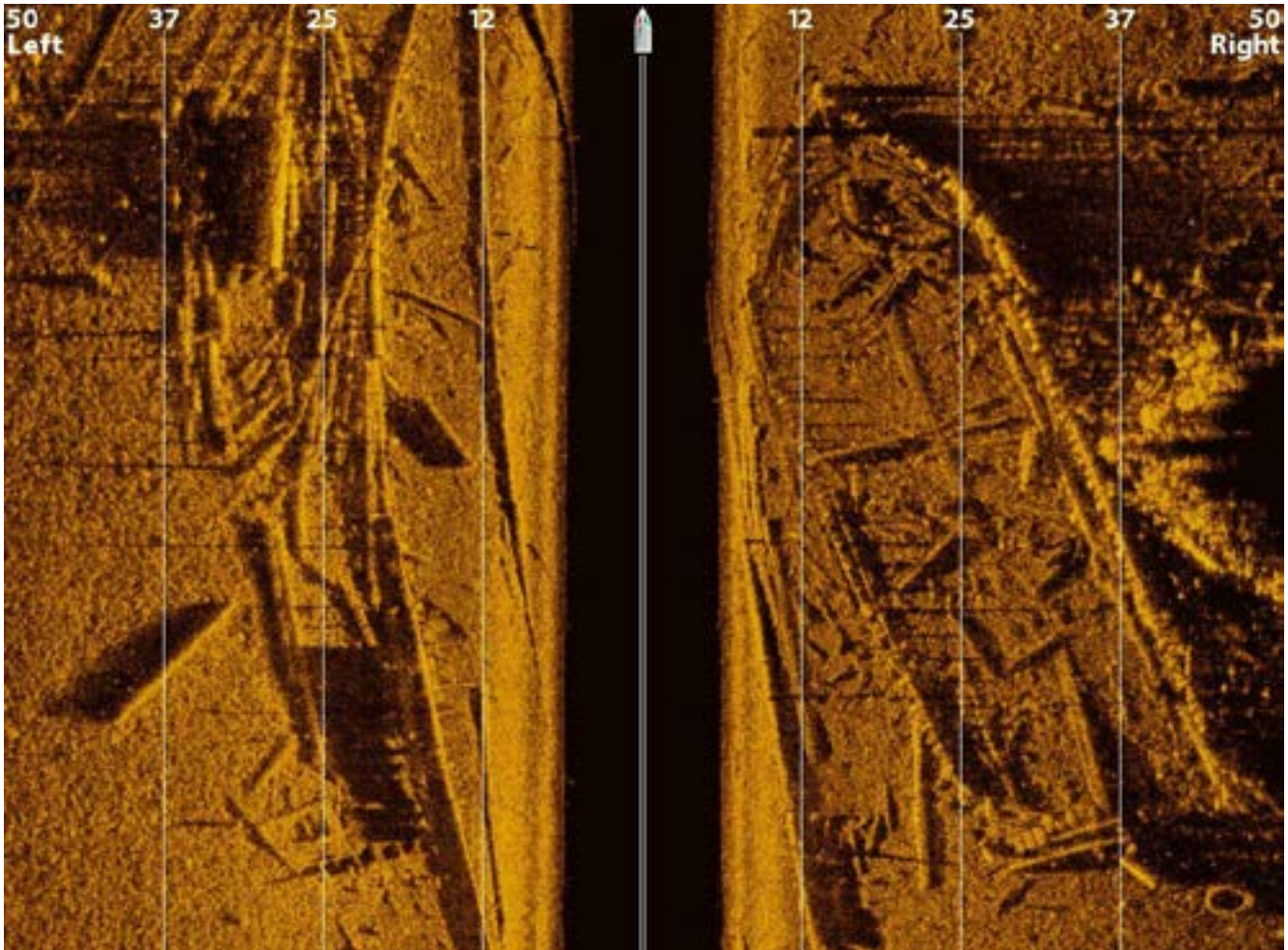

Figure 3. The Funkhouser Fleet as seen with side imaging sonar. North is down and Vessel 1 may be seen on the starboard channel (right), Vessel 2 is bifurcated by the nadir zone, and vessels 3 and 4 may be seen on the port channel.

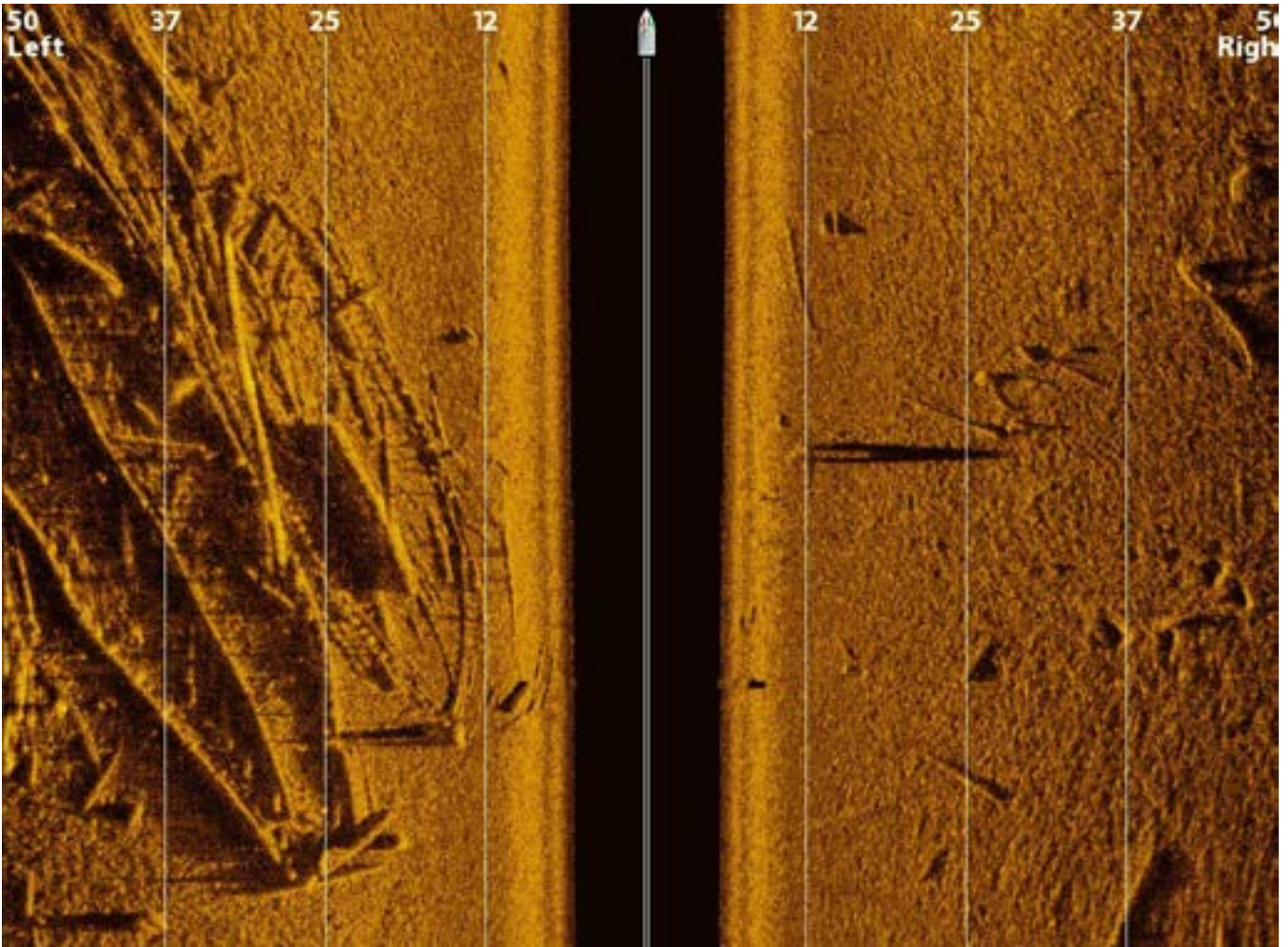
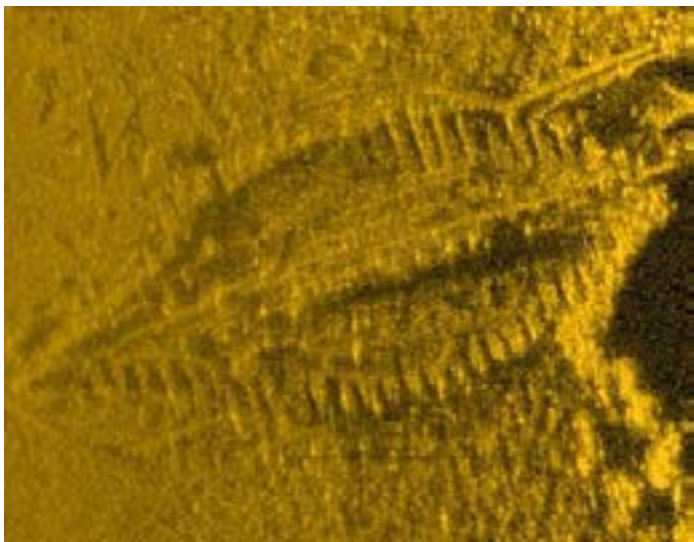

Figure 4. Vessel 4 may be seen in this side imaging view, a possible skipjack. Note the centerboard trunk proud above the wreck's framing.

APPENDIX 4: ACOUSTIC CONTACTS REPORT

Name	Date	06/10/2019
NGF-A020	Time	15:18:09
Survey File	Event	0
R00006	X	894365.5
Capture File	Y	4074995.7
NGF-A020.JPG	WGS84 Latitude	36 44 19.5977 N
	WGS84 Longitude	076 35 2.589 W
	Heading	101.3
	Fish Altitude	2.00
	Range to Target	10.4
	Height Above Bottom	0.0
	Length	15.0
	Width	5.4

Notes	Length: 15.0 Width: 5.4 1050 KHz
-------	---



Name	Date	06/10/2019
Tire	Time	15:13:56
Survey File	Event	0
R00006	X	894259.7
Capture File	Y	4075197.3
tire.JPG	WGS84 Latitude	36 44 26.279 N
	WGS84 Longitude	076 35 6.4682 W
	Heading	177.2
	Fish Altitude	1.60
	Range to Target	9.2
	Height Above Bottom	0.0
	Length	0.8
	Width	1.0

Notes	Length: 0.8 Width: 1.0 1050 KHz
-------	--



Name	Date	06/10/2019
NGF-A034	Time	14:46:58
Survey File	Event	0
R00006	X	894320.3
Capture File	Y	4075334.2
NGF-A034.JPG	WGS84 Latitude	36 44 30.618 N
	WGS84 Longitude	076 35 3.7776 W
	Heading	4.8
	Fish Altitude	3.30
	Range to Target	11.0
	Height Above Bottom	0.0
	Length	8.2
	Width	0.7

Notes	Length: 8.2 Width: 0.7 1050 KHz
-------	--

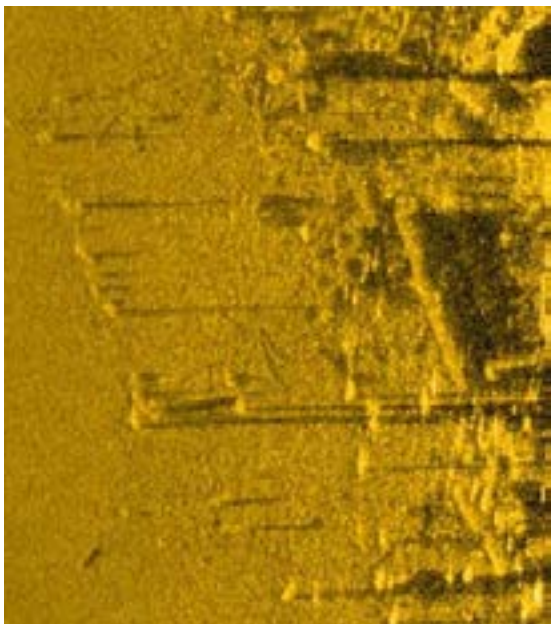

Name	Date	06/10/2019
NGF-A032	Time	14:44:10
Survey File	Event	0
R00006	X	894340.6
Capture File	Y	4075185.3
NGF-A032.JPG	WGS84 Latitude	36 44 25.7698 N
	WGS84 Longitude	076 35 3.238 W
	Heading	350.2
	Fish Altitude	3.90
	Range to Target	8.7
	Height Above Bottom	0.0
	Length	8.2
	Width	2.5

Notes	Length: 8.2 Width: 2.5 1050 KHz
-------	--

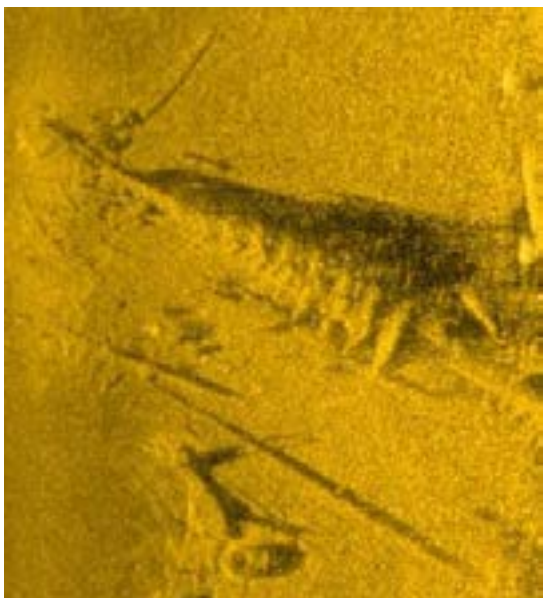

Name	Date	06/10/2019
NGF-A035	Time	15:56:23
Survey File	Event	0
R00008	X	894096.8
Capture File	Y	4075615.2
NGF-A035.JPG	WGS84 Latitude	36 44 40.0443 N
	WGS84 Longitude	076 35 12.2417 W
	Heading	142.6
	Fish Altitude	2.80
	Range to Target	16.7
	Height Above Bottom	0.0
	Length	10.5
	Width	12.0

Notes	Length: 10.5 Width: 12.0 1050 KHz
-------	--

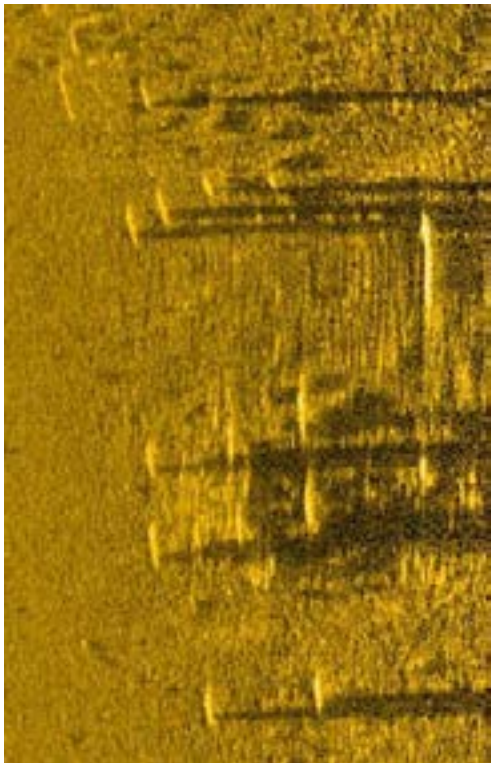

Name	Date	06/10/2019
NGF-A027	Time	16:12:12
Survey File	Event	0
R00009	X	894289.2
Capture File	Y	4075074.3
NGF-A027.JPG	WGS84 Latitude	36 44 22.255 N
	WGS84 Longitude	076 35 5.5106 W
	Heading	286.5
	Fish Altitude	2.10
	Range to Target	17.3
	Height Above Bottom	0.0
	Length	15.7
	Width	7.5

Notes	Length: 15.7 Width: 7.5 1050 KHz
-------	---

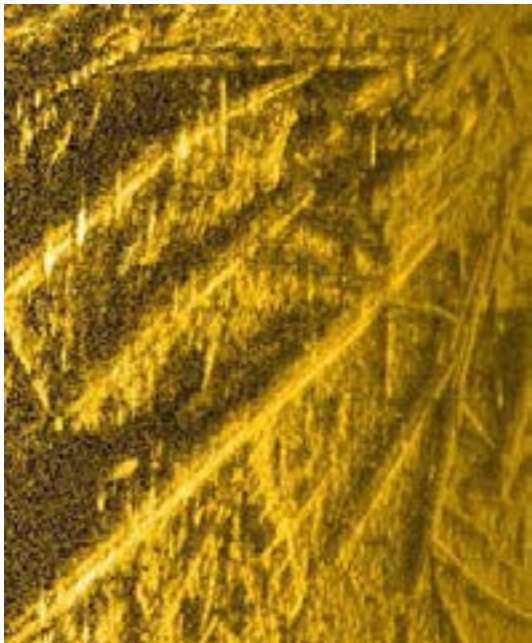

Name	Date	06/10/2019
NGF-A031	Time	16:15:27
Survey File	Event	0
R00010	X	894258.2
Capture File	Y	4075142.6
NGF-A031.JPG	WGS84 Latitude	36 44 24.5113 N
	WGS84 Longitude	076 35 6.63 W
	Heading	101.2
	Fish Altitude	1.50
	Range to Target	6.4
	Height Above Bottom	0.0
	Length	4.2
	Width	1.5

Notes	Length: 4.2 Width: 1.5 1050 KHz
-------	--

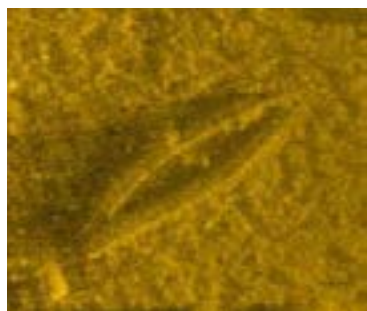

Name	Date	06/10/2019
NGF-A028	Time	16:19:46
Survey File	Event	0
R00011	X	894305.6
Capture File	Y	4075087.4
NGF-A028.JPG	WGS84 Latitude	36 44 22.6543 N
	WGS84 Longitude	076 35 4.8269 W
	Heading	271.8
	Fish Altitude	2.90
	Range to Target	14.7
	Height Above Bottom	0.0
	Length	15.7
	Width	5.1

Notes	Length: 15.7 Width: 5.1 1050 KHz
-------	---



Name	Date	06/10/2019
NGF-A026	Time	16:23:42
Survey File	Event	0
R00013	X	894284.9
Capture File	Y	4075062.4
NGF-A026.JPG	WGS84 Latitude	36 44 21.8764 N
	WGS84 Longitude	076 35 5.7055 W
	Heading	198.1
	Fish Altitude	1.80
	Range to Target	12.7
	Height Above Bottom	0.0
	Length	23.9
	Width	5.6

Notes	Length: 23.9 Width: 5.6 1050 KHz
-------	---

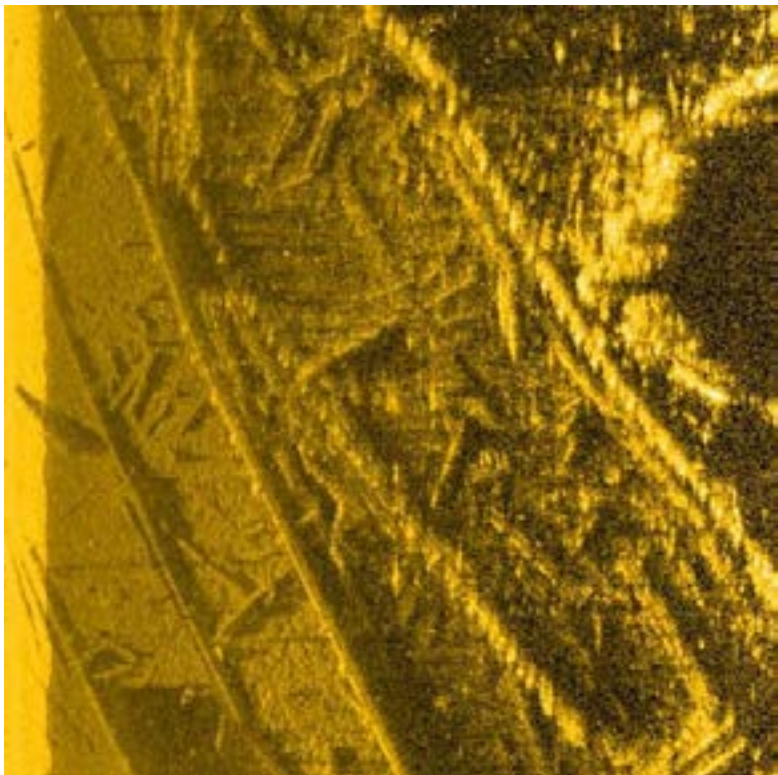

ame	Date	06/10/2019
NGF-A024	Time	16:26:36
Survey File	Event	0
R00015	X	894304.9
Capture File	Y	4075088.4
NGF-A024.JPG	WGS84 Latitude	36 44 22.6877 N
	WGS84 Longitude	076 35 4.8532 W
	Heading	227.2
	Fish Altitude	2.10
	Range to Target	11.7
	Height Above Bottom	0.0
	Length	15.3
	Width	5.4

Notes	Length: 15.3 Width: 5.4 1050 KHz
-------	---



Name	Date	06/10/2019
NGF-A025	Time	16:26:57
Survey File	Event	0
R00015	X	894290.9
Capture File	Y	4075071.4
NGF-A025.JPG	WGS84 Latitude	36 44 22.1586 N
	WGS84 Longitude	076 35 5.4476 W
	Heading	221.4
	Fish Altitude	1.90
	Range to Target	10.9
	Height Above Bottom	0.1
	Length	22.6
	Width	6.1

Notes	Height: 0.1 Length: 22.6 Width: 6.1 1050 KHz
-------	--

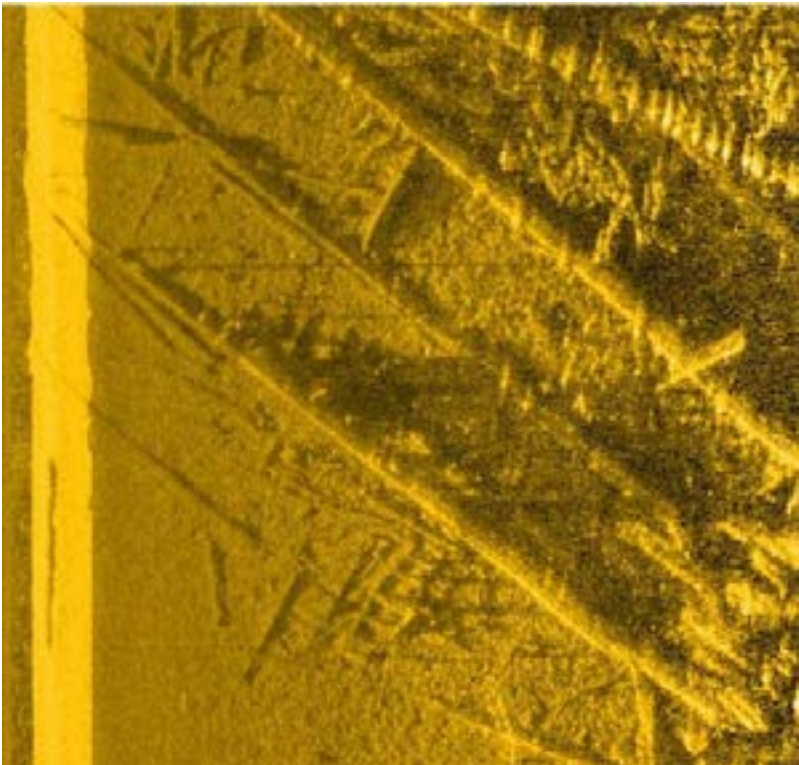

Name	Date	06/10/2019
NGF-A019	Time	16:40:14
Survey File	Event	0
R00019	X	894365.8
Capture File	Y	4074998.1
NGF-A019.JPG	WGS84 Latitude	36 44 19.6749 N
	WGS84 Longitude	076 35 2.5725 W
	Heading	85.6
	Fish Altitude	1.80
	Range to Target	6.9
	Height Above Bottom	0.0
	Length	11.3
	Width	4.7

Notes	FEATURE 11. Hobbs Wreck Length: 11.3 Width: 4.7 1050 KHz
-------	---



Name	Date	06/10/2019
NGF-A013	Time	14:24:36
Survey File	Event	0
R00023	X	894492.1
Capture File	Y	4075053.1
NGF-A013.JPG	WGS84 Latitude	36 44 21.2657 N
	WGS84 Longitude	076 34 57.3927 W
	Heading	66.0
	Fish Altitude	6.60
	Range to Target	14.7
	Height Above Bottom	0.0
	Length	8.1
	Width	8.5

Notes	Length: 8.1 Width: 8.5 1050 KHz
-------	--



Name	Date	06/10/2019
NGF-A012	Time	14:26:30
Survey File	Event	0
R00023	X	894596.7
Capture File	Y	4075106.3
NGF-A012.JPG	WGS84 Latitude	36 44 22.8307 N
	WGS84 Longitude	076 34 53.0887 W
	Heading	69.8
	Fish Altitude	5.70
	Range to Target	10.3
	Height Above Bottom	0.4
	Length	15.8
	Width	16.6

Notes	Height: 0.4 Length: 15.8 Width: 16.6 1050 KHz
-------	--

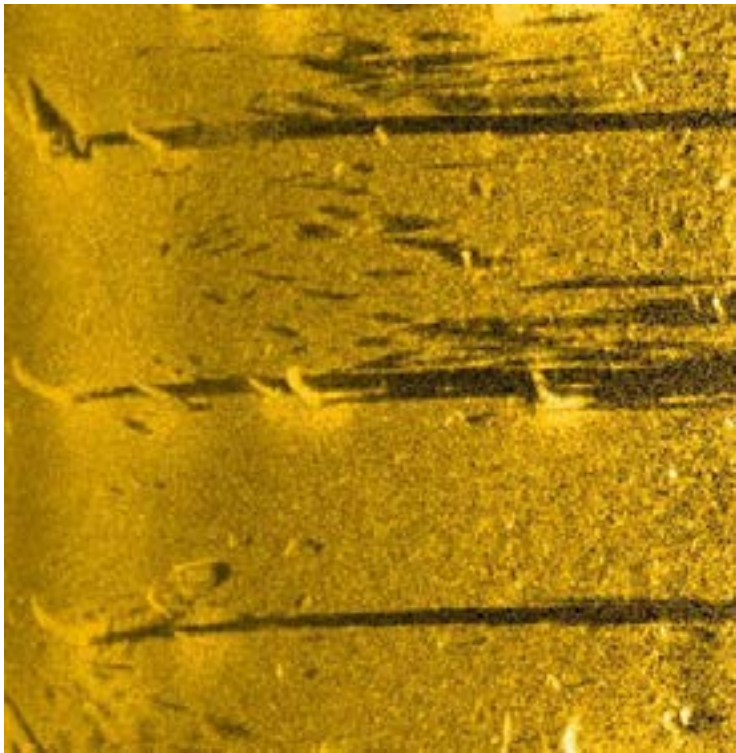

Name	Date	06/10/2019
NGF-A011	Time	14:28:54
Survey File	Event	0
R00023	X	894720.9
Capture File	Y	4075156.1
NGF-A011.JPG	WGS84 Latitude	36 44 24.2562 N
	WGS84 Longitude	076 34 48 W
	Heading	69.4
	Fish Altitude	3.60
	Range to Target	16.4
	Height Above Bottom	0.0
	Length	11.9
	Width	6.1

Notes	Length: 11.9 Width: 6.1 1050 KHz
-------	---



Name	Date	06/10/2019
NGF-A010	Time	14:30:21
Survey File	Event	0
R00023	X	894796.3
Capture File	Y	4075184.5
NGF-A010.JPG	WGS84 Latitude	36 44 25.0623 N
	WGS84 Longitude	076 34 44.9187 W
	Heading	76.8
	Fish Altitude	2.60
	Range to Target	15.2
	Height Above Bottom	0.0
	Length	11.9
	Width	1.0

Notes	Length: 11.9 Width: 1.0 1050 KHz
-------	---

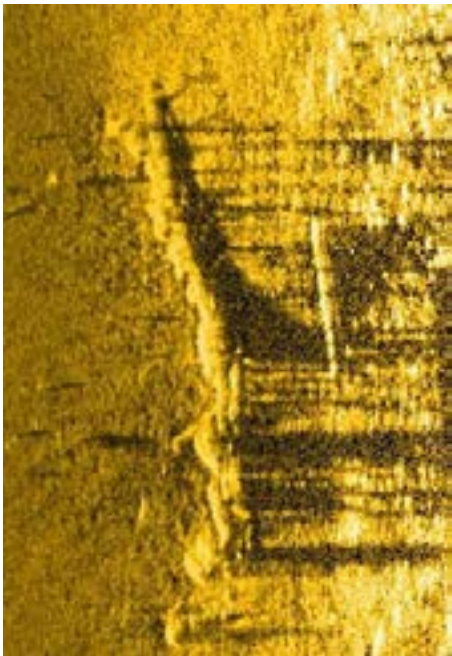

Name	Date	06/10/2019
NGF-A009	Time	14:30:35
Survey File	Event	0
R00023	X	894812.4
Capture File	Y	4075186.7
NGF-A009.JPG	WGS84 Latitude	36 44 25.1094 N
	WGS84 Longitude	076 34 44.2674 W
	Heading	71.4
	Fish Altitude	2.60
	Range to Target	17.3
	Height Above Bottom	0.0
	Length	8.5
	Width	1.2

Notes	Length: 8.5 Width: 1.2 1050 KHz
-------	--



Name	Date	06/10/2019
NGF-A008	Time	14:31:29
Survey File	Event	0
R00023	X	894861.6
Capture File	Y	4075208.8
NGF-A008.JPG	WGS84 Latitude	36 44 25.7509 N
	WGS84 Longitude	076 34 42.2483 W
	Heading	69.0
	Fish Altitude	2.50
	Range to Target	15.0
	Height Above Bottom	0.0
	Length	19.5
	Width	7.2

Notes	Length: 19.5 Width: 7.2 1050 KHz
-------	---

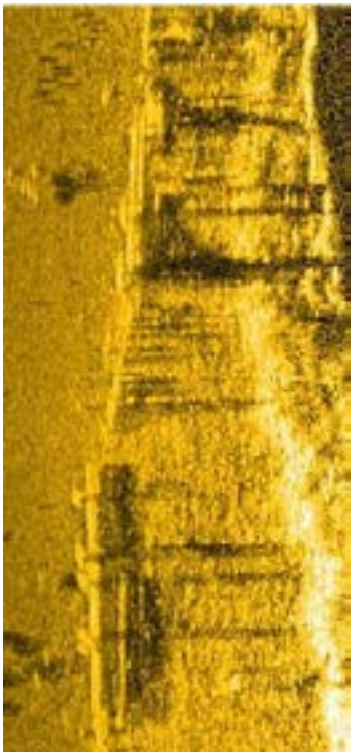

Name	Date	06/10/2019
NGF-A007	Time	14:31:48
Survey File	Event	0
R00023	X	894879.5
Capture File	Y	4075215.3
NGF-A007.JPG	WGS84 Latitude	36 44 25.9344 N
	WGS84 Longitude	076 34 41.5165 W
	Heading	69.2
	Fish Altitude	2.60
	Range to Target	16.2
	Height Above Bottom	0.0
	Length	18.5
	Width	5.7

Notes	Length: 18.5 Width: 5.7 1050 KHz
-------	---

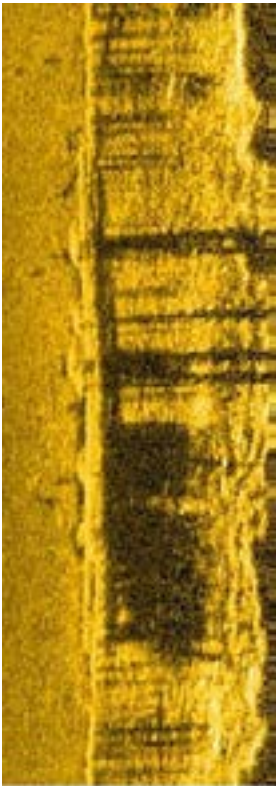

Name	Date	06/10/2019
NGF-A006	Time	14:32:12
Survey File	Event	0
R00023	X	894899.3
Capture File	Y	4075226.5
	WGS84 Latitude	36 44 26.2672 N
	WGS84 Longitude	076 34 40.6997 W
	Heading	75.1
	Fish Altitude	2.60
	Range to Target	13.4
	Height Above Bottom	0.0
	Length	19.4
	Width	5.6

Notes	Length: 19.4 Width: 5.6 1050 KHz
-------	---

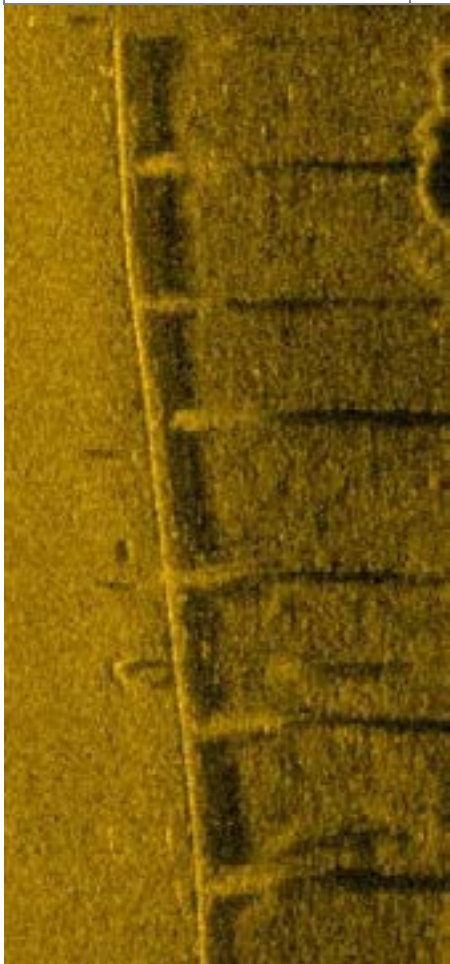

Name	Date	06/10/2019
NGF-A005	Time	14:32:08
Survey File	Event	0
R00023	X	894895.7
Capture File	Y	4075225.7
NGF-A005.JPG	WGS84 Latitude	36 44 26.2467 N
	WGS84 Longitude	076 34 40.8459 W
	Heading	75.4
	Fish Altitude	2.60
	Range to Target	12.5
	Height Above Bottom	0.0
	Length	18.7
	Width	6.3

Notes	Length: 18.7 Width: 6.3 1050 KHz
-------	---

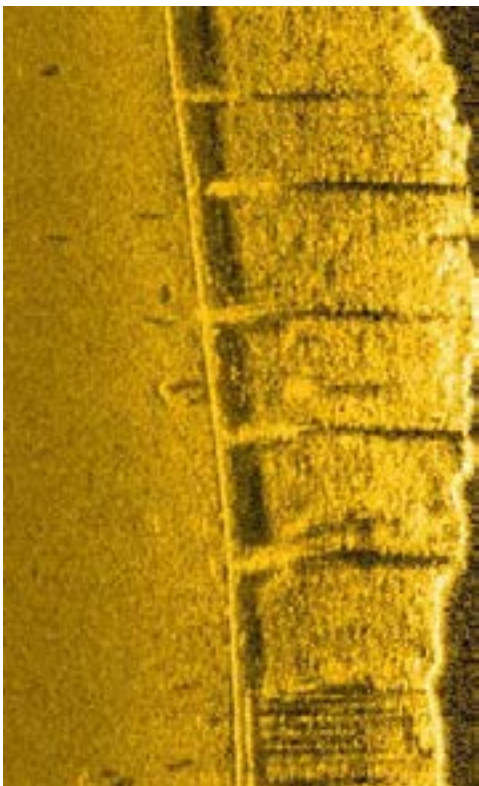

Name	Date	06/10/2019
NGF-A004	Time	14:39:39
Survey File	Event	0
R00023	X	895182.5
Capture File	Y	4075526.4
NGF-A004.JPG	WGS84 Latitude	36 44 35.5468 N
	WGS84 Longitude	076 34 28.7559 W
	Heading	31.3
	Fish Altitude	3.10
	Range to Target	9.5
	Height Above Bottom	0.0
	Length	10.0
	Width	8.4

Notes	Length: 10.0 Width: 8.4 1050 KHz
-------	---

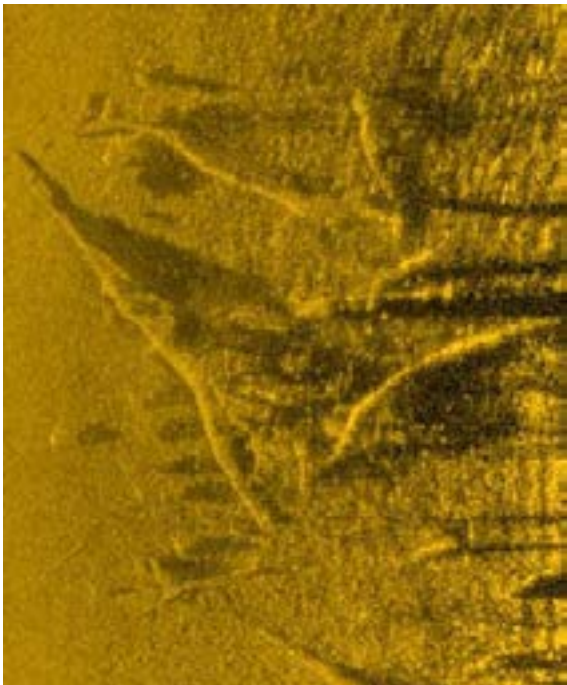

Name	Date	06/10/2019
NGF-A001	Time	14:59:49
Survey File	Event	0
R00024	X	895225.0
Capture File	Y	4075774.1
NGF-A001.JPG	WGS84 Latitude	36 44 43.4978 N
	WGS84 Longitude	076 34 26.5861 W
	Heading	215.6
	Fish Altitude	3.00
	Range to Target	19.1
	Height Above Bottom	0.0
	Length	9.2
	Width	4.5

Notes	Length: 9.2 Width: 4.5 1050 KHz
-------	--



Name	Date	06/10/2019
NGF-A002	Time	14:49:55
Survey File	Event	0
R00023	X	895494.8
Capture File	Y	4075495.2
NGF-A002.JPG	WGS84 Latitude	36 44 34.0692 N
	WGS84 Longitude	076 34 16.2582 W
	Heading	344.3
	Fish Altitude	2.40
	Range to Target	15.4
	Height Above Bottom	0.0
	Length	10.1
	Width	7.3

Notes	Length: 10.1 Width: 7.3 1050 KHz
-------	---



Name	Date	06/10/2019
NGF-A003	Time	14:41:11
Survey File	Event	0
R00023	X	895248.3
Capture File	Y	4075569.7
NGF-A003.JPG	WGS84 Latitude	36 44 36.8492 N
	WGS84 Longitude	076 34 26.0298 W
	Heading	76.6
	Fish Altitude	2.20
	Range to Target	7.3
	Height Above Bottom	0.0
	Length	8.2
	Width	3.1

Notes	Length: 8.2 Width: 3.1 1050 KHz
-------	--

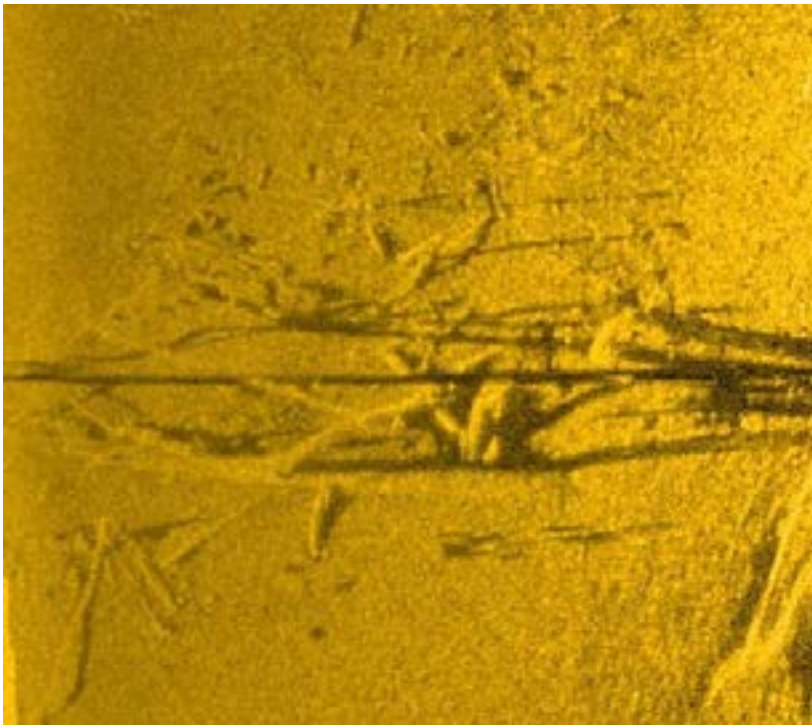

Name	Date	06/10/2019
NGF-A022	Time	13:45:50
Survey File	Event	0
R00025	X	894363.3
Capture File	Y	4074994.2
NGF-A022.JPG	WGS84 Latitude	36 44 19.5525 N
	WGS84 Longitude	076 35 2.6803 W
	Heading	278.6
	Fish Altitude	2.10
	Range to Target	6.1
	Height Above Bottom	0.0
	Length	12.6
	Width	5.1

Notes	Length: 12.6 Width: 5.1 1050 KHz
-------	---

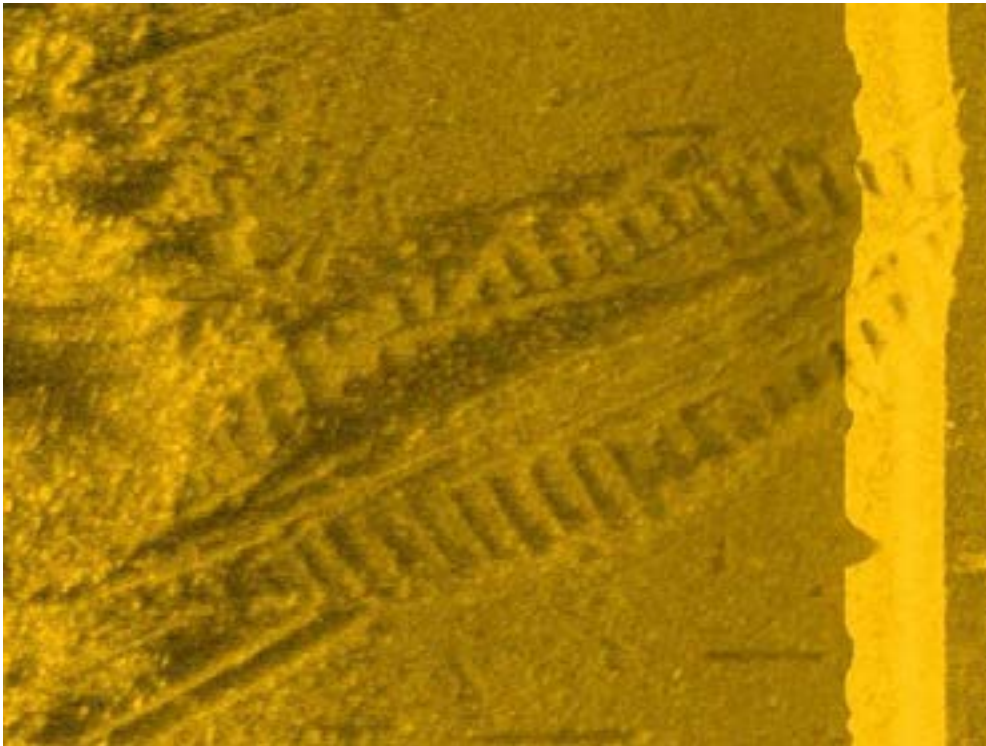

Name	Date	06/10/2019
NGF-A023	Time	13:47:40
Survey File	Event	0
R00025	X	894293.2
Capture File	Y	4075061.7
NGF-A023.JPG	WGS84 Latitude	36 44 21.8413 N
	WGS84 Longitude	076 35 5.3731 W
	Heading	4.1
	Fish Altitude	2.00
	Range to Target	15.0
	Height Above Bottom	0.2
	Length	25.8
	Width	6.2

Notes	Height: 0.2 Length: 25.8 Width: 6.2 1050 KHz
-------	---

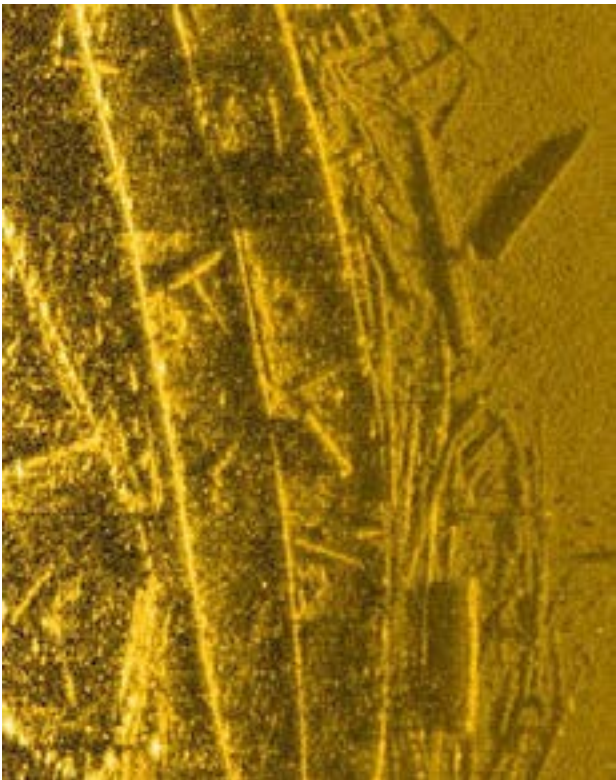

Name	Date		06/10/2
NGF-A032	Time		13:50:4
Survey File	Event		0
R00025	X		894346
Capture File	Y		407518
NGF-A032.JPG	WGS84 Latitude		36 44 2
	WGS84 Longitude		076 35
	Heading		178.9
	Fish Altitude		4.30
	Range to Target		8.4
	Height Above Bottom		0.3
	Length		10.6
	Width		1.9

Notes	Height: 0.3 Length: 10.6 Width: 1.9 1050 KHz
-------	---

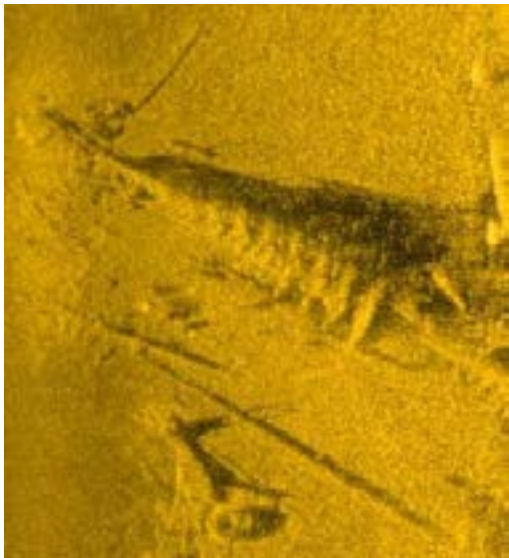

Name	Date	06/10/2019
NGF-A033	Time	13:50:51
Survey File	Event	0
R00025	X	894329.7
Capture File	Y	4075180.4
NGF-A033.JPG	WGS84 Latitude	36 44 25.6275 N
	WGS84 Longitude	076 35 3.6853 W
	Heading	176.9
	Fish Altitude	4.40
	Range to Target	11.4
	Height Above Bottom	0.0
	Length	3.0
	Width	2.1

Notes	Length: 3.0 Width: 2.1 1050 KHz
-------	--

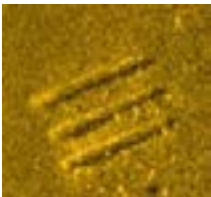

Name	Date	06/10/2019
NGF-A030	Time	14:12:36
Survey File	Event	0
R00027	X	894313.0
Capture File	Y	4075085.5
NGF-A030.JPG	WGS84 Latitude	36 44 22.5818 N
	WGS84 Longitude	076 35 4.5329 W
	Heading	114.5
	Fish Altitude	2.00
	Range to Target	12.2
	Height Above Bottom	0.0
	Length	17.8
	Width	4.4

Notes	Length: 17.8 Width: 4.4 1050 KHz
-------	---

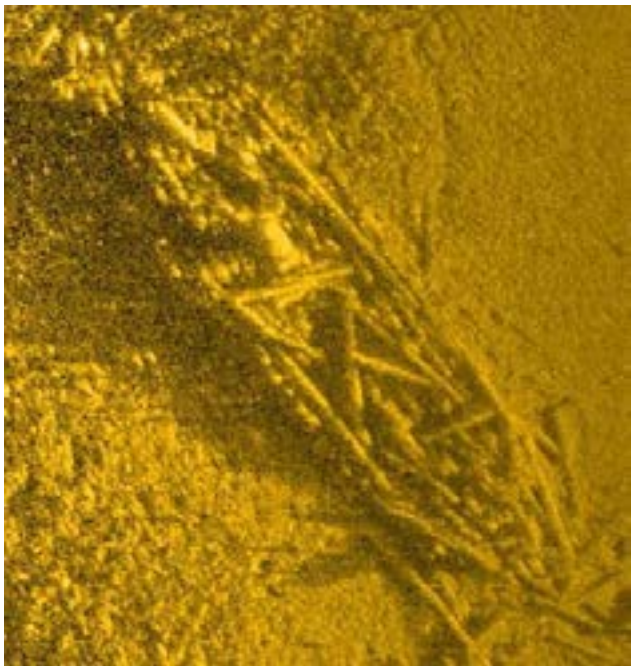

Name	Date	06/10/2019
NGF-A029	Time	14:12:21
Survey File	Event	0
R00027	X	894284.5
Capture File	Y	4075062.1
NGF-A029.JPG	WGS84 Latitude	36 44 21.8673 N
	WGS84 Longitude	076 35 5.7222 W
	Heading	113.0
	Fish Altitude	2.00
	Range to Target	20.7
	Height Above Bottom	0.0
	Length	19.4
	Width	8.4

Notes	Length: 19.4 Width: 8.4 1050 KHz
-------	---

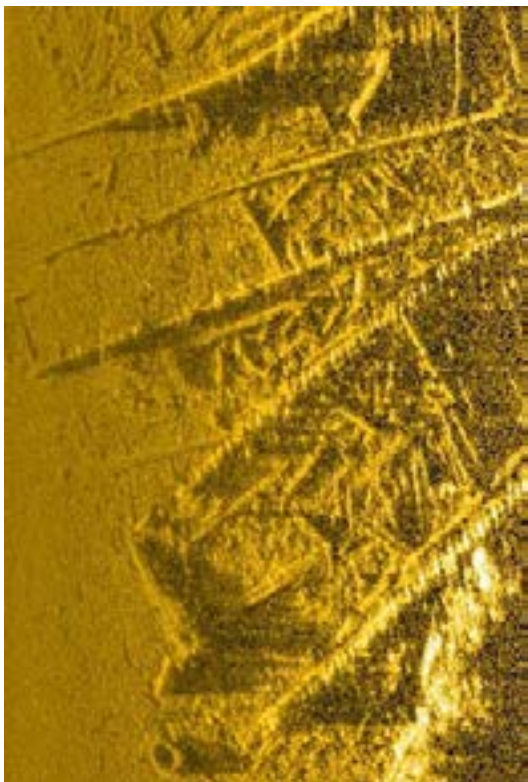

Name	Date	06/10/2019
NGF-A018	Time	15:22:58
Survey File	Event	0
R00006	X	894386.4
Capture File	Y	4075074.1
NGF-A018.JPG	WGS84 Latitude	36 44 22.1032 N
	WGS84 Longitude	076 35 1.6032 W
	Heading	314.5
	Fish Altitude	4.70
	Range to Target	19.5
	Height Above Bottom	0.0
	Length	9.9
	Width	4.5

Notes	Length: 9.9 Width: 4.5 1050 KHz
-------	--



Name	Date	06/10/2019
NGF-A017	Time	15:22:41
Survey File	Event	0
R00006	X	894392.9
Capture File	Y	4075068.1
NGF-A017.JPG	WGS84 Latitude	36 44 21.8994 N
	WGS84 Longitude	076 35 1.353 W
	Heading	299.5
	Fish Altitude	5.40
	Range to Target	19.7
	Height Above Bottom	0.0
	Length	10.4
	Width	9.2

Notes	Length: 10.4 Width: 9.2 1050 KHz
-------	---

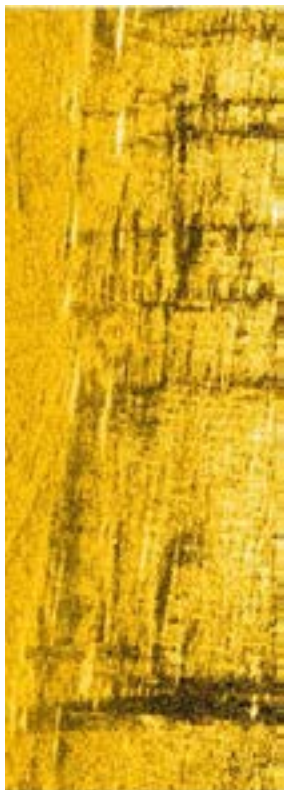

Name	Date	06/10/2019
NGF-A016	Time	15:22:16
Survey File	Event	0
R00006	X	894409.1
Capture File	Y	4075062.4
NGF-A016.JPG	WGS84 Latitude	36 44 21.6907 N
	WGS84 Longitude	076 35 0.7123 W
	Heading	284.1
	Fish Altitude	6.00
	Range to Target	20.0
	Height Above Bottom	0.5
	Length	12.6
	Width	6.8

Notes	Height: 0.5 Length: 12.6 Width: 6.8 1050 KHz
-------	---

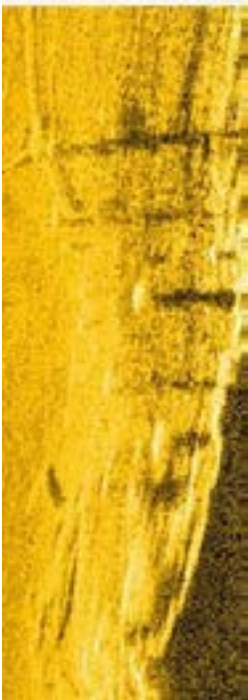

Name	Date	06/10/2019
NGF-A015	Time	15:18:36
Survey File	Event	0
R00006	X	894389.3
Capture File	Y	4075000.9
NGF-A015.JPG	WGS84 Latitude	36 44 19.7304 N
	WGS84 Longitude	076 35 1.6226 W
	Heading	68.1
	Fish Altitude	4.20
	Range to Target	9.6
	Height Above Bottom	0.0
	Length	5.3
	Width	0.6

Notes	Length: 5.3 Width: 0.6 1050 KHz
-------	--

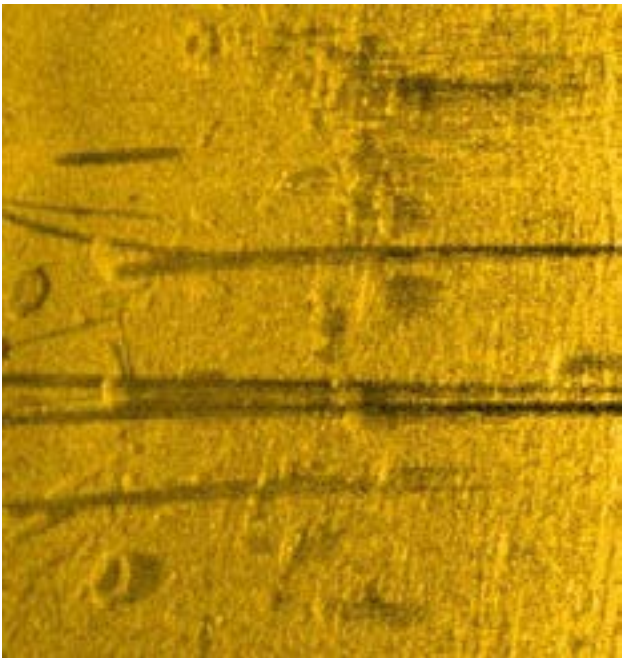

Name	Date	06/10/2019
NGF-A014	Time	15:19:32
Survey File	Event	0
R00006	X	894426.4
Capture File	Y	4075014.0
NGF-A014.JPG	WGS84 Latitude	36 44 20.0988 N
	WGS84 Longitude	076 35 0.1067 W
	Heading	78.9
	Fish Altitude	6.30
	Range to Target	11.0
	Height Above Bottom	0.0
	Length	11.2
	Width	4.2

Notes	Length: 11.2 Width: 4.2 1050 KHz
-------	---

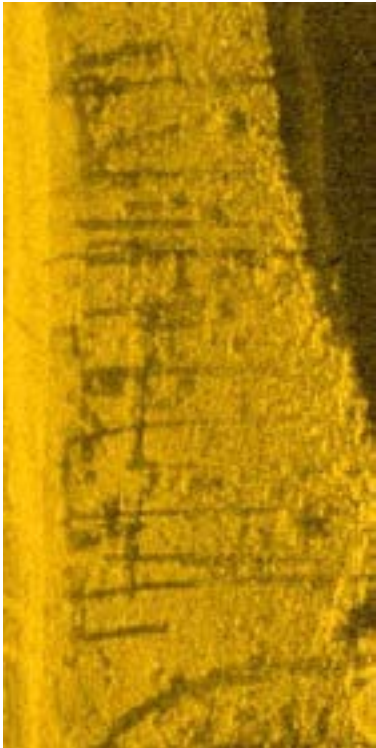

03 OCT 2019
 HUBBS SITE
 NOF
 B. BURRILL, L. HEDIN

Bit side frame installed on track 12 Oct. Sided. 13 Oct. pulled
 - track 12 on upper side of track 13. 13 Oct. pulled to track = 88 long 72cm wide.
 Frame 6 after full 12. 20 Oct. sided 12. 3 Oct. installed. End post 10 cm wide of 1.1
 Space between measured in field measured base 10 cm between track 8 & 6
 " " 6 + 7 12.5 cm
 " " 6 + 7 12.5 cm
 Offsets frame 6 = 2.0 cm

DESCRIPTION	SIZE	DATE	NOTES
wood 12 cm, round	12.5"	30	
Frame 72cm long	72"	Apr. 7	
along track, 80"	80 cm	with 21 cm	after using track 12.5 cm
cutting track 6 feet	60 cm	with 18 cm	12.5 cm
Kaliforn	72"	Apr. 30.6	
12.5 cm offset			Apr. 31, 12.5 cm
offset 12.5 cm	offset 12"	width 12"	
Actual post diameter	12.5"	21 cm	with track 12.5 cm
Frame 88	12"	13	Requirements table @ 12.5 cm

U/W 0706
 @ SITE 0710

1 OCT 2019
 NGF
 B.B., A.B.

VESSEL #1

LOA - 25.57M

BEAM - 6.84M, MEAS @ 12.25M ON BARRICADE

VESSEL #1

PORT BEAM OFFSETS

ON BARRICADE	OFFSET
1	.75
2	1.42
3	2.20
4	2.28
5	3.05
5.4	3.25 ← TURN OF BOW
6	3.33
7	3.34
8	3.46
9	3.45
10	3.44
11	3.41
12	3.41
13	3.43
14	3.43
15	3.43
16	3.42
17	3.42
18	3.42
19	3.43
20	3.43
21	3.42
22	3.44
23	3.43
24	3.45
25	3.42 AFT-MOST

STBD BEAM OFFSETS

ON BARRICADE	OFFSET
1	.75
2	1.43
3	2.18
3.25	2.52
4	2.82
5	3.13
6	3.33
6.35	3.41
7	3.52
8	3.43
9	3.41
10	3.41
11	3.43
12	3.40
13	3.39
14	3.39
15	3.37
16	3.36
17	3.33
18	3.34
19	3.35
20	3.34
21	3.30
22	3.33
23	3.30
24	3.30
25	3.29
25.28	3.12 AFT-MOST



12.25

APPENDIX 6: MID-ATLANTIC LOGBOAT REGISTRY: NOTES FROM RIDDICK'S FOLLY MUSEUM, LOG BOAT, FEATURE 7

June 11, 2020

Mid-Atlantic Logboat Registry Notes on Riddick's Folly Logboat: Information requested to be added as Feature 7 of Ghost Fleet Survey represented in VCRIS 44SK0631.

Original Finder and Informant: Byron Carmean (2015)

Initial Measurements/Photos and Documented Field Survey: Bob and Mary Hayes, Mid-Atlantic Logboat Registry Team, Maritime Heritage Chapter, Archeological Society of Virginia

Timeline of Discovery/Investigation:

- During the 2015 shoreline survey for the Nansemond River Preservation Alliance, local tree expert Mr. Carmean found the logboat and reported the find to Mr. Kermit Hobbs and Mr. Lee King of Riddick's Folly House Museum.

March 2017: The logboat was recovered by Riddick's Folly House Museum and Suffolk Nansemond Historical Society (effort led by Kermit Hobbs and Lee King and members Bobby Buck, Larry Riddick, Sandra Council). The logboat was loaded onto a pickup truck and moved to the back covered porch of the Riddick's Folly Museum where it can currently be found. During the recovery, no documented measurements were taken, only photos.

Sept/Oct 2018: Bob and Mary Hayes, Project Coordinators for the Mid-Atlantic Logboat Registry (project of the Maritime Heritage Chapter of the Archeological Society of Virginia) found articles from March 2017 in the Suffolk News Herald and Virginian-Pilot newspapers on the logboat find and recovery. Mr. and Mrs. Hayes met with Mr. Hobbs and Lee King and performed the initial measurements and details of the logboat for the registry, and took additional photographs.

Logboat Details:

1. Map coordinates where logboat was found on the shoreline: (provided by Mr. Kermit Hobbs): 36 degrees, 44.306 minutes north; 76 degrees 35.026 minutes west.

2. Wood identification: Bryan Carmean states that wood is "heart" yellow pine (no confirmation of this via lab results). Mr. and Mrs. Hayes took initial samples but wood was so dried out and deteriorated samples were not sent off for analysis.

3. Logboat is not complete but appears to be a large section/fragment.

-
4. Based on iron pin placement appears to be at least three logs. Iron pins are placed horizontally (method common in multi-log boat construction).

 5. Length of logboat fragment is 14.58 ft; width at widest is 2.92 ft. Thickness of what appears to be keel log ranges from 3-4 inches.

 6. Stern has a drilled through 2 inch diameter hole and other fabrication features for what may have been a propeller shaft. Boat may have had an engine but no mount for a motor found.

 7. Photos taken during logboat recovery show underside of logboat has a wooden plug and two vertical spikes along the keel line, suggesting that something else was attached (the nails are no longer present on the fragment at Riddick's Folly).

 8. Current condition: Badly deteriorated and dried out, and being impacted by seasonal weather conditions without protection.

 9. Age: Unknown, but post contact. Based on stern shape and use of iron pins vessel most likely built/used in late 19th century and may have been abandoned along with other Ghost Fleet vessels.

 10. Laser line scan of logboat completed by Longwood Institute of Archaeology (Longwood University) January 2020.

RESEARCH REPORT SERIES

- No. 1: Colonial Plantation Hoes of Tidewater Virginia (1980)
- No. 2: Archaeological Test Excavations of Site 44RU7 at a Late Woodland Village in Lower Uplands of Southwest Virginia Russell County (1981)
- No. 3: Ceramic Study of Woodland Occupation Along the Clinch and Powell Rivers in Southwest Virginia (1987)
- No. 4: Archaeological Investigations of Sites 44JC70 and 44JC71 at Croaker Landing James City County (1988)
- No. 5: Native American Sites in a Fall Line Transition Study Area (1989)
- No. 6: Blacksmith Shops in Catawba, Virginia: Archeological and Historical Investigation (1994)
- No. 7: Archaeological Assessment of Sites 44PY7, 44PY43, 44PY152 at Leesville Lake, Pittsylvania County (1996)
- No. 8: Archaeological Investigations of Site 44SX202, Cactus Hill, Sussex County, Virginia (1997)
- No. 9: Native American Settlement at Great Neck: Report on VDHR Archaeological Investigations of Woodland Components at Site 44VB7, Virginia Beach (1998)
- No. 10: The Potomac Creek Site (44ST2) Revisited Stafford County (1999)
- No. 11: The Life of a Potter, Andrew Pittman (44FK528) Frederick County (2001)
- No. 12: Early Horticultural Settlement in the James River Piedmont: Excavations at the Partridge Creek Site (44AH193), Stapleton, Amherst County (2003)
- No. 13: The Williamson Clovis Site, 44DW1, Dinwiddie County, Virginia: An Analysis of Research Potential in Threatened Areas (2003)
- No. 14: Emergency Excavations at the Sawyer Site (44RN39), Area B: A Protohistoric Site in Roanoke County, Virginia (2004)
- No. 15: The Buzzard Rock Site (44RN2): A Late Woodland Dispersed Village Roanoke (2005)
- No. 16: The Bonham Site (44SM7): A Late Woodland Village Complex in Smyth County, Virginia (2005)
- No. 17: The Werowocomoco (44GL32) Research Project: Background and 2003 Archaeological Field Season Results Gloucester County (2007)
- No. 18: Archaeological Investigation of the Remains of Two Early 18th-Century Vessels in the Mattaponi River at Newington Plantation, King and Queen County (2013)
- No. 19: The Werowocomoco Research Project: 2004–2010 Seasons
- No. 21: High Plains Sappony of Person Co, NC & Halifax Co, VA: Sites of Significance in Christie Indian Settlement (2017)
- No. 22: The Millie Woodson-Turner Nottoway Reservation Allotment and Farmstead (2017)
- No. 23: Heritage Properties of Indian Town: The Mattaponi Indian Baptist Church, School, and Homes of Chiefly Lineages (2017)

